

2026 PRODUCT DATA

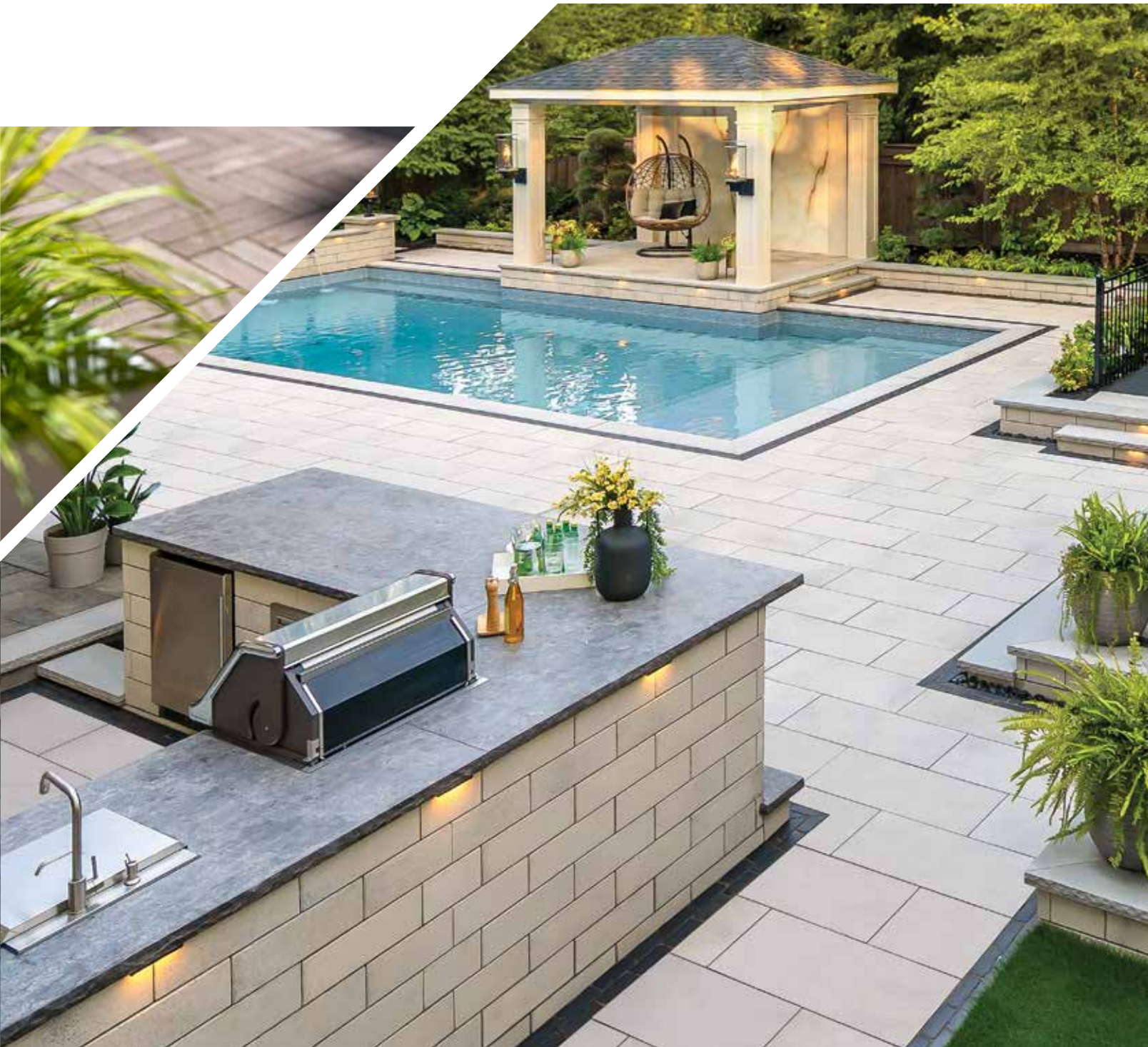

TRANSFORMING
HARDSCAPES



VIEW

AR

LANDSCAPE VISUALIZER

Exclusive to **UNILOCK**

IMPRESS CLIENTS ON THE SPOT

Simply pan the yard using Uview™ and bring your vision to life in real time with pavers, walls, and vertical elements to get homeowners excited about the possibilities.



**DOWNLOAD
NOW**

PART OF A COMPLETE TOOL-KIT

 LEVEL™

 VISION™
3D LANDSCAPE CREATOR

***SPEED-CALC*™**
PAVER AND WALL CALCULATOR

PAVERS

- 04** ADA Paver
- 05** Anchorlock™
- 06** Arcana™
- 07** Artline™ Il Campo® Finish
- 08** Artline™ Smooth Finish
- 09** Artline™ Umbriano® Finish
- 10** Beacon Hill™ Flagstone 60mm
- 11** Beacon Hill™ Flagstone 80mm
- 12** Beacon Hill™ Smooth 60mm
- 13** Beacon Hill™ Smooth with Easy Clean
- 14** Beacon Hill™ Smooth 80mm
- 15** Bristol Valley® 60mm
- 16** Bristol Valley® 80mm
- 17** Brussels Block®
- 18** Cophorne®
- 19** Courtstone®
- 20** Eco-Hex™
- 21** Eco-Line®
- 22** Eco-Optiloc™
- 23** Eco-Priora™
- 24** Eco-Priora™ Premier
- 25** Eco-Promenade® Ecoterra
- 26** Eco-Promenade® Series™
- 27** Eco-Promenade® Umbriano®
- 28** Holland Premier™
- 29** Hollandstone™ 60mm
- 30** Hollandstone™ 80mm
- 31** Mattoni™
- 32** Natural Stone Slabs
- 33** Natural Stone Random Bundle
- 34** Natural Stone Coping
- 36** Natural Stone Steps & Pillar Caps
- 37** Nordic Cobble™
- 38** Optiloc®
- 39** Porcelain
- 42** Promenade™ 70mm & 150mm
- 43** Promenade™ 100mm
- 44** Richcliff®
- 45** Series™ 60mm
- 46** Skyline™
- 47** Soreno™
- 48** Town Hall®
- 49** Treo™ Smooth
- 50** Tribeca Cobble™
- 51** Turfstone™
- 52** Umbriano® 60mm
- 53** Umbriano® 60mm Slabs
- 54** Westport™
- 55** Westport™ Smooth

WALLS

- 56** Brussels Dimensional Stone®
- 57** Dura Hold®
- 58** Estate Wall™
- 59** Lineo™ Dimensional Stone
- 60** Olde Quarry™
- 61** Pisa™ & Pisa XL
- 62** Pisa™ XL Smooth
- 63** Quarry™ Smooth
- 64** Rivercrest® Wall
- 65** Rivercrest® Pillar and Fire Pit kit
- 66** SienaEdge™
- 67** SienaStone™
- 68** SienaStone™ Smooth
- 69** U-Cara® Multi-Face Wall System
- 69** U-Cara® Multi-Face Wall System
- 71** U-Cara® Fascia Panels
- 73** U-Cara® Backer
- 74** U-Cara® Modular System
- 75** U-Cara® Wall Mount System

COPING, STEPS, PILLAR CAPS AND FIRE FEATURES

- 76** Endura™ Coping 24x14
- 77** Endura™ Coping & Pillar Cap
- 78** Brussels Fullnose™ & Fullnose Edger
- 79** Ledgestone™
- 81** Umbriano® Coping
- 82** Umbriano® Coping
- 83** Universal U-Grip™ Base
- 84** Sunset Fire Pit Kit
- 85** Unilock Elements

ACCESSORIES

- 86** SkyView™
- 87** Cleaning Products
- 87** Adhesive Products
- 88** Sealing Products
- 88** Sand Products
- 89** Permeable Chip Products
- 89** Resin Sand Products
- 90** Geotextiles and Fabric Products
- 90** Miscellaneous Items
- 90** Stainless Steel Fireplace Insert
- 91** Edging Products
- 92** Turf products

PRODUCTS & INSTALLATION INFORMATION

- 93** Unilock Pedestal System
- 95** Sealer Best Practices
- 95** Polysand Best Practices
- 96** 2026 Freight Rates
- 96** Important notes
- 98** Terms and Conditions of Sale
- 99** Unilock Finishes
- 100** Color Blend Descriptions

DESCRIPTION OF PAVER EDGE DETAILS



Zero-Edge



Chamfered Edge



Rounded Bevel



Micro Bevel

ADA Paver



APPLICATIONS

Pedestrian, Light Vehicular, Border/Accents

APPEARANCE

Edge Detail - Chamfer

Surface Texture - Smooth

Joint Spacing - 3 mm

DRIVE FRIENDLY

Can handle vehicular loads

TECHNICAL INFORMATION

Conforms to ASTM C936

LEED Eligible

EPD's & HPD's available

	12 x 12
Bundle Type	SINGLE
Plant Produced	CHICAGO
Thickness (mm)	70 mm

SQFT PER	Stone	0.97
	Layer	11.63
	Bundle	93.04

PER BUNDLE	Layers	8.00
------------	--------	------

SOLDIER LNFT PER	SqFt	1.02
	Layer	11.81
	Bundle	94.49

SAILOR LNFT PER	SqFt	1.02
	Layer	11.81
	Bundle	94.49

UNITS PER	SqFt	1.03
	Layer	12.00
	Bundle	96.00

LBS PER	Unit	32
	Layer	389
	Bundle	3,114

Colors	Reflectance	Stock
Charcoal	SR n/a SRI n/a	SO
Red	SR n/a SRI n/a	SO



CHARCOAL



RED

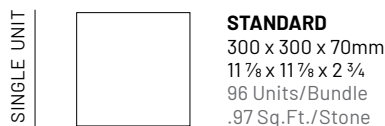
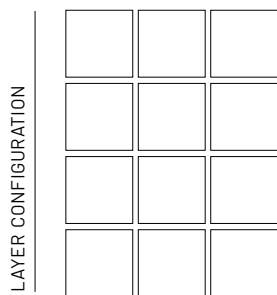

Notes: **Special Order (SO)**, Lead time required. Minimum quantities apply. **SOLD IN FULL BUNDLES ONLY**. All measurements are nominal. Contact Unilock for more information.

Anchorlock™



APPLICATIONS

Pedestrian, Light Vehicular, Roadway Street, Heavy-duty

APPEARANCE

Edge Detail - Chamfer

Surface Texture - Smooth

Joint Spacing - 3 mm

DRIVE FRIENDLY

Can handle vehicular loads

TECHNICAL INFORMATION

Conforms to ASTM C936

LEED Eligible

EPD's & HPD's available

	8 7/8 x 8 7/8
Bundle Type	SINGLE
Plant Produced	CHICAGO
Thickness (mm)	80 mm

SQFT PER	Stone	0.41
	Layer	10.84
	Bundle	86.72

PER BUNDLE	Layers	8.00
------------	--------	------

SOLDIER LNFT PER	SqFt	-
	Layer	-
	Bundle	-

SAILOR LNFT PER	SqFt	-
	Layer	-
	Bundle	-

UNITS PER	SqFt	2.46
	Layer	26.67
	Bundle	213.36

LBS PER	Unit	14
	Layer	374
	Bundle	2,991

Colors	Reflectance	Stock
Natural	SR .30 SRI 32	SO



NATURAL

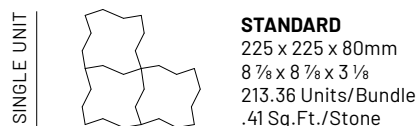
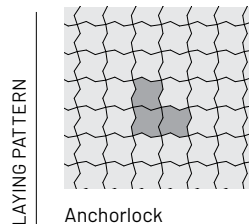

Notes: Special Order (SO), Lead time required. SOLD IN FULL BUNDLES ONLY. Minimum quantities apply. 1/3 stones incorporated in each bundle; 16 pieces per bundle. The 1/3 stone is not shown. Product is optimized for mechanical installation. All measurements are nominal. Contact Unilock for more information.



	12 x 24	18 x 24	24 x 24
Bundle Type	SINGLE	SINGLE	SINGLE
Plant Produced	CHICAGO	CHICAGO	CHICAGO
Thickness (mm)	50 mm	50 mm	50 mm

SQFT PER	Stone	2.00	3.00	4.00
	Bundle	36.00	54.00	72.00

SOLDIER LNFT PER	SqFt	0.99	0.99	0.99
	Bundle	35.55	53.50	71.57

SAILOR LNFT PER	SqFt	1.99	1.33	0.99
	Bundle	71.57	71.57	71.57

UNITS PER	SqFt	0.50	0.33	0.25
	Bundle	18.00	18.00	18.00

LBS PER	Unit	48	72	96
	Bundle	864	1,296	1,728

Colors	Reflectance	Stock	Stock	Stock
Avorio	SR .56 SRI 66	✓	✓	✓
Corvara	SR .32 SRI 34	✓	✓	✓
Ferrano	SR n/a SRI n/a	✓	✓	✓
Modena	SR .46 SRI 53	✓	✓	✓
Vivanto	SR .18 SRI 16	✓	✓	✓

APPLICATIONS

Pedestrian, Roof Deck

APPEARANCE

Edge Detail - Micro
Surface Texture - Smooth
Joint Spacing - 0 mm

TECHNICAL INFORMATION

Conforms to ASTM C 1782
LEED Eligible
EPD's & HPD's available

// Perfect for roof decks and other raised floor applications.

Ask us about our Skyview™ pedestal system. See page 84 for more information.

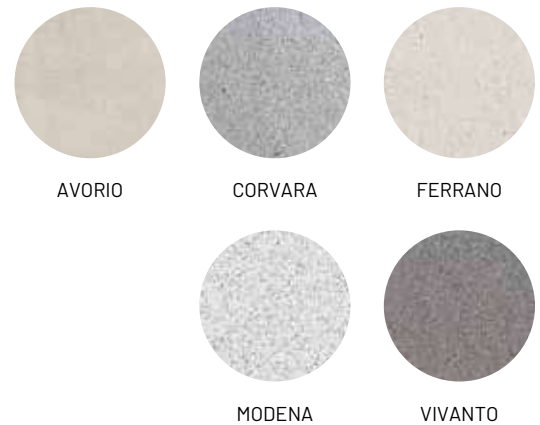

AVORIO

CORVARA

FERRANO

MODENA

VIVANTO

SLAB SPACERS



X & T Slab Spacers
Bagged & Sold Separately.
See page 88 for more information.

LAYING PATTERNS

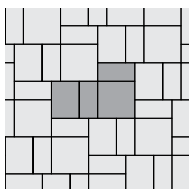

Random A

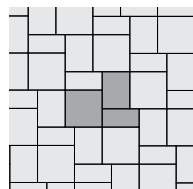

Random C

SINGLE UNITS



12 x 24
301 x 606 x 50mm
11 7/8 x 23 7/8 x 2"
18 Units/Bundle
2 Sq.Ft./Stone



18 x 24
453 x 606 x 50mm
17 7/8 x 23 7/8 x 2"
18 Units/Bundle
3 Sq.Ft./Stone

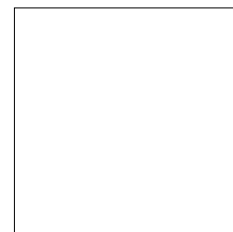

24 x 24
606 x 606 x 50mm
23 7/8 x 23 7/8 x 2"
18 Units/Bundle
4 Sq.Ft./Stone

Notes: **SOLD IN FULL BUNDLES ONLY** and is produced and sold on a required, refundable skid. **This product is not intended for vehicular applications. Important: A urethane rubber paver mat must be used to prevent scuffing when compacting.** All measurements are nominal. Unilock recommends installing Arcana using X & T Slab Spacers. Please see page 88. Contact Unilock for more information. **STOCKED AT AURORA & ELKHORN (TRANSFERABLE ON REQUEST TO TONGANOXIE)**



APPLICATIONS

Pedestrian, Light Vehicular

APPEARANCE

Edge Detail - Micro

Surface Texture - Il Campo Brushed

Joint Spacing - 3 mm

TECHNICAL INFORMATION

Conforms to ASTM C 936

LEED Eligible

EPD's & HPD's available

Bundle Type	RANDOM
Plant Produced	CHICAGO
Thickness (mm)	70 mm

SQFT PER	Stone	-
	Layer	11.66
	Bundle	93.25

PER BUNDLE	Layers	8.00
------------	--------	------

SOLDIER LNFT PER	SqFt	-
	Layer	-
	Bundle	-

SAILOR LNFT PER	SqFt	-
	Layer	-
	Bundle	-

UNITS PER	SqFt	-
	Layer	24.00
	Bundle	192.00

LBS PER	Unit	-
	Layer	370
	Bundle	2,963

Colors	Reflectance	Stock
Bavarian Blend	SR n/a SRI n/a	✓
Granite Blend	SR n/a SRI n/a	✓

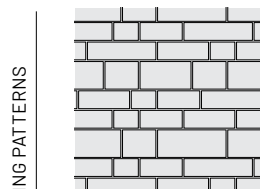
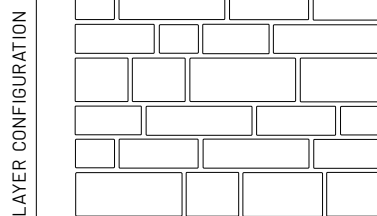

Artline Random



BAVARIAN BLEND

GRANITE BLEND

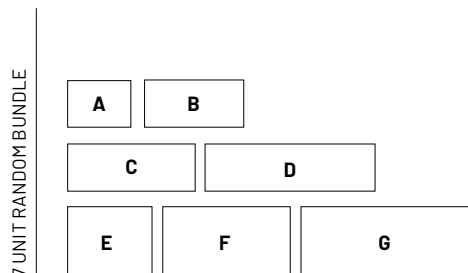

UNIT A
125 x 169 x 70mm
4 7/8 x 6 3/4 x 2 3/4"
32 Units/Bundle
.23 Sq.Ft./Stone

UNIT B
125 x 262.5 x 70mm
4 7/8 x 10 3/8 x 2 3/4"
32 Units/Bundle
.35 Sq.Ft./Stone

UNIT C
125 x 337.5 x 70mm
4 7/8 x 13 3/8 x 2 3/4"
32 Units/Bundle
.45 Sq.Ft./Stone

UNIT D
125 x 450 x 70mm
4 7/8 x 17 3/4 x 2 3/4"
32 Units/Bundle
.61 Sq.Ft./Stone

UNIT E
187.5 x 225 x 70mm
7 1/2 x 8 7/8 x 2 3/4"
32 Units/Bundle
.45 Sq.Ft./Stone

UNIT F
187.5 x 337.5 x 70mm
7 1/2 x 13 3/8 x 2 3/4"
16 Units/Bundle
.69 Sq.Ft./Stone

UNIT G
187.5 x 450 x 70mm
7 1/2 x 17 3/4 x 2 3/4"
16 Units/Bundle
.91 Sq.Ft./Stone

Notes: SOLD IN FULL BUNDLES ONLY and is produced and sold on a required, refundable skid. **Important: A urethane rubber paver mat must be used to prevent scuffing when compacting.** All measurements are nominal. Contact Unilock for more information. **STOCKED AT AURORA, ELKHORN & TONGANOXIE**



APPLICATIONS

Pedestrian, Light Vehicular

APPEARANCE

Edge Detail - Micro

Surface Texture - Smooth

Joint Spacing - 3 mm

TECHNICAL INFORMATION

Conforms to ASTM C 936

LEED Eligible

EPD's & HPD's available

Bundle Type	RANDOM
Plant Produced	MARENGO
Thickness (mm)	70 mm

SQFT PER	Stone	-
	Layer	11.66
	Bundle	93.25

PER BUNDLE	Layers	8.00
------------	--------	------

SOLDIER LNFT PER	SqFt	-
	Layer	-
	Bundle	-

SAILOR LNFT PER	SqFt	-
	Layer	-
	Bundle	-

UNITS PER	SqFt	-
	Layer	24.00
	Bundle	192.00

LBS PER	Unit	-
	Layer	370
	Bundle	2,963

Colors	Reflectance	Stock
Bavarian Blend	SR n/a SRI n/a	✓
Steel Mountain	SR .30 SRI 32	✓

LAYER CONFIGURATION

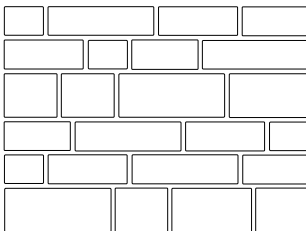

LAYING PATTERNS

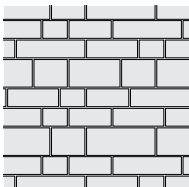

Artline Random

7 UNIT RANDOM BUNDLE

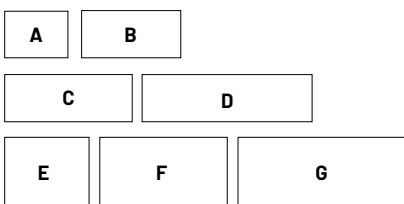

UNIT A

125 x 169 x 70mm
4 7/8 x 6 3/4 x 2 3/4"
32 Units/Bundle
.23 Sq.Ft./Stone

UNIT B

125 x 262.5 x 70mm
4 7/8 x 10 3/8 x 2 3/4"
32 Units/Bundle
.35 Sq.Ft./Stone

UNIT C

125 x 337.5 x 70mm
4 7/8 x 13 3/8 x 2 3/4"
32 Units/Bundle
.45 Sq.Ft./Stone

UNIT D

125 x 450 x 70mm
4 7/8 x 17 3/4 x 2 3/4"
32 Units/Bundle
.61 Sq.Ft./Stone

UNIT E

187.5 x 225 x 70mm
7 1/2 x 8 7/8 x 2 3/4"
32 Units/Bundle
.45 Sq.Ft./Stone

UNIT F

187.5 x 337.5 x 70mm
7 1/2 x 13 3/8 x 2 3/4"
16 Units/Bundle
.69 Sq.Ft./Stone

UNIT G

187.5 x 450 x 70mm
7 1/2 x 17 3/4 x 2 3/4"
16 Units/Bundle
.91 Sq.Ft./Stone

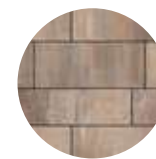

BAVARIAN BLEND

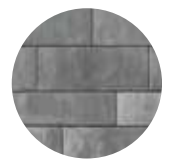

STEEL MOUNTAIN

Notes: SOLD IN FULL BUNDLES ONLY and is produced and sold on a required, refundable skid. Important: A urethane rubber paver mat must be used to prevent scuffing when compacting. All measurements are nominal. Contact Unilock for more information. STOCKED AT AURORA, ELKHORN, MARENGO & TONGANOXIE



APPLICATIONS

Pedestrian, Light Vehicular

APPEARANCE

Edge Detail - Micro

Surface Texture - Umbriano Mottled

Joint Spacing - 3 mm

TECHNICAL INFORMATION

Conforms to ASTM C 936

LEED Eligible

EPD's & HPD's available

Bundle Type	RANDOM
Plant Produced	MARENGO
Thickness (mm)	70 mm

SQFT PER	Stone	-
	Layer	11.66
	Bundle	93.25

PER BUNDLE	Layers	8.00
------------	--------	------

SOLDIER LNFT PER	SqFt	-
	Layer	-
	Bundle	-

SAILOR LNFT PER	SqFt	-
	Layer	-
	Bundle	-

UNITS PER	SqFt	-
	Layer	24.00
	Bundle	192.00

LBS PER	Unit	-
	Layer	373
	Bundle	2,986

Colors	Reflectance	Stock
French Grey	SR .18 SRI 17	✓
Midnight Sky	SR .17 SRI 15	✓
Winter Marvel	SR .35 SRI 38	✓

LAYER CONFIGURATION

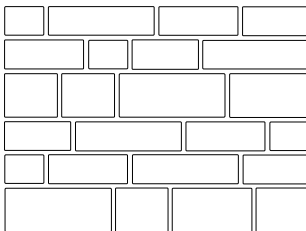

LAYING PATTERNS

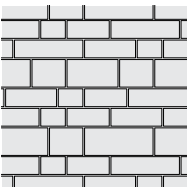

Artline Random

7 UNIT RANDOM BUNDLE

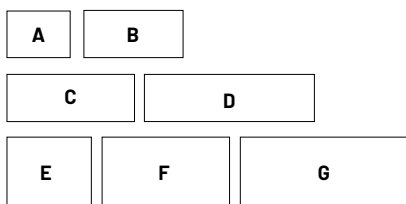

UNIT A

125 x 169 x 70mm
4 7/8 x 6 3/4 x 2 3/4"
32 Units/Bundle
.23 Sq.Ft./Stone

UNIT B

125 x 262.5 x 70mm
4 7/8 x 10 3/8 x 2 3/4"
32 Units/Bundle
.35 Sq.Ft./Stone

UNIT C

125 x 337.5 x 70mm
4 7/8 x 13 3/8 x 2 3/4"
32 Units/Bundle
.45 Sq.Ft./Stone

UNIT D

125 x 450 x 70mm
4 7/8 x 17 3/4 x 2 3/4"
32 Units/Bundle
.61 Sq.Ft./Stone

UNIT E

187.5 x 225 x 70mm
7 1/2 x 8 7/8 x 2 3/4"
32 Units/Bundle
.45 Sq.Ft./Stone

UNIT F

187.5 x 337.5 x 70mm
7 1/2 x 13 3/8 x 2 3/4"
16 Units/Bundle
.69 Sq.Ft./Stone

UNIT G

187.5 x 450 x 70mm
7 1/2 x 17 3/4 x 2 3/4"
16 Units/Bundle
.91 Sq.Ft./Stone



FRENCH GREY

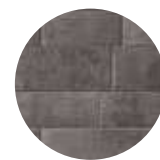

MIDNIGHT SKY



WINTER MARVEL

Notes: SOLD IN FULL BUNDLES ONLY and is produced and sold on a required, refundable skid. Important: A urethane rubber paver mat must be used to prevent scuffing when compacting. All measurements are nominal. Contact Unilock for more information. STOCKED AT AURORA, ELKHORN, MARENGO & TONGANOXIE



APPLICATIONS

Pedestrian

APPEARANCE

Edge Detail - Rounded

Surface Texture - Textured

Joint Spacing - 4 mm

TECHNICAL INFORMATION

Conforms to ASTM C 936

LEED Eligible - EPD's & HPD's available

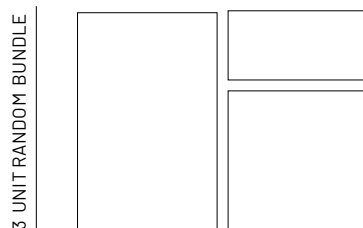
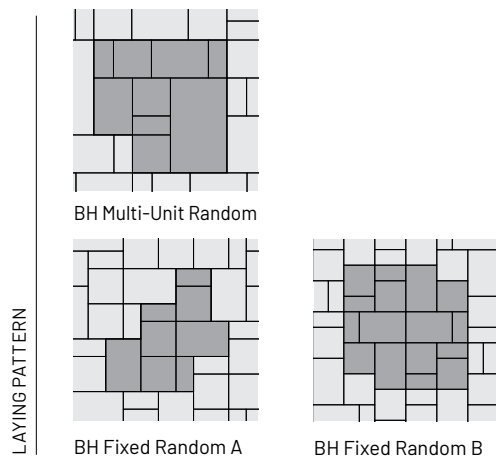
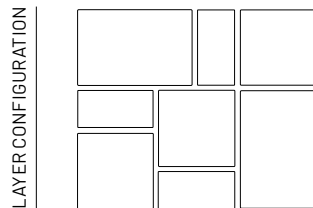

LARGE RECTANGLE

380 x 570 x 60mm
15 x 22 1/2 x 2 3/8"
20 Units/Bundle
2.33 SqFt./Stone

SQUARE

380 x 380 x 60mm
15 x 15 x 2 3/8"
30 Units/Bundle
1.55 Sq.Ft./Stone

SMALL RECTANGLE

380 x 190 x 60mm
15 x 7 1/2 x 2 3/8"
30 Units/Bundle
.78 Sq.Ft./Stone

SINGLE UNITS



XL UNIT

950 x 570 x 60mm
37 1/2 x 22 1/2 x 2 3/8"
20 Units/Bundle
5.83 Sq.Ft./Stone

			XL UNIT
	Bundle Type	RANDOM	SINGLE
	Plant Produced	MARENGO	MARENGO
	Thickness (mm)	60 mm	60 mm

SQFT PER	Stone	-	5.83
	Layer	11.66	11.66
	Bundle	116.57	116.57

PER BUNDLE	Layers	10.00	10.00
------------	--------	-------	-------

SOLDIER LNFT PER	SqFt	-	0.32
	Layer	-	3.74
	Bundle	-	37.40

SAILOR LNFT PER	SqFt	0.80	0.53
	Layer	9.35	6.23
	Bundle	93.50	62.30

UNITS PER	SqFt	-	0.17
	Layer	8.00	2.00
	Bundle	80.00	20.00

LBS PER	Unit	-	162
	Layer	322	324
	Bundle	3,196	3,238

Colors	Reflectance	Stock	Stock
Alpine Grey	SR n/a SRI n/a	✓	✓
Bavarian Blend	SR n/a SRI n/a	✓	✓
Fossil	SR .22 SRI 21	✓	✓

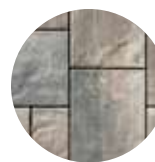

ALPINE GREY

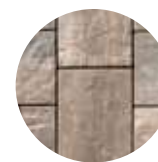

BAVARIAN BLEND



FOSSIL

Notes: **SOLD IN FULL BUNDLES ONLY** and is produced and sold on a required, refundable skid. **This product is not intended for vehicular applications. Important: A urethane rubber paver mat must be used to prevent scuffing when compacting.**
All measurements are nominal. Contact Unilock for more information. **STOCKED AT AURORA, ELKHORN, MARENGO & TONGANOXIE**

Beacon Hill™ Flagstone 80mm



APPLICATIONS

Pedestrian, Light Vehicular

APPEARANCE

Edge Detail - Rounded

Surface Texture - Textured

Joint Spacing - 4 mm

TECHNICAL INFORMATION

Conforms to ASTM C 936

LEED Eligible

EPD's & HPD's available

Bundle Type	RANDOM
Plant Produced	MARENGO
Thickness (mm)	80 mm

SQFT PER	Stone	1.46
	Layer	11.66
	Bundle	81.60

PER BUNDLE	Layers	7.00
------------	--------	------

SOLDIER LNFT PER	SqFt	-
	Layer	-
	Bundle	-

SAILOR LNFT PER	SqFt	0.80
	Layer	9.35
	Bundle	65.45

UNITS PER	SqFt	0.69
	Layer	8.00
	Bundle	56.00

LBS PER	Unit	53
	Layer	426
	Bundle	2,979

Colors	Reflectance	Stock
Custom Colors	SR n/a SRI n/a	SO
Please contact your local Sales Representative for color options.		

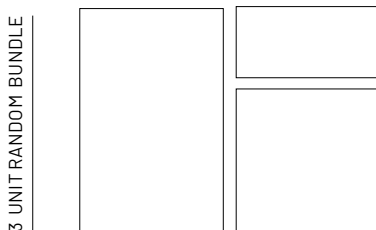
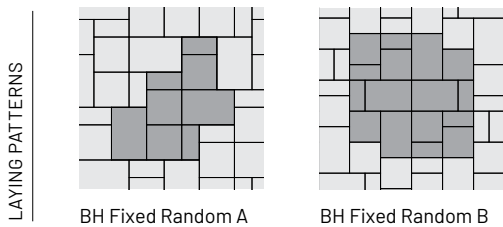
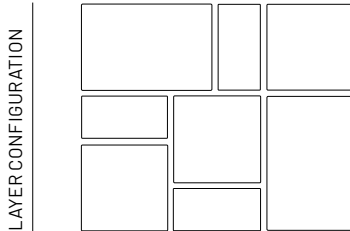

LARGE RECTANGLE
 380 x 570 x 80mm
 15 1/2 x 22 1/2 x 3 1/8"
 14 Units/Bundle
 2.33 SqFt./Stone

SQUARE
 380 x 380 x 80mm
 15 x 15 x 3 1/8"
 21 Units/Bundle
 1.55 Sq.Ft./Stone

SMALL RECTANGLE
 380 x 190 x 80mm
 15 x 7 1/2 x 3 1/8"
 21 Units/Bundle
 .78 Sq.Ft./Stone

Notes: Special Order (SO), Lead time required. Minimum quantities apply. **SOLD IN FULL BUNDLES ONLY** and is produced and sold on a required, refundable skid. **Important: A urethane rubber paver mat must be used to prevent scuffing when compacting.** All measurements are nominal. Contact Unilock for more information. **STOCKED AT AURORA, ELKHORN, MARENGO & TONGANOXIE**



APPLICATIONS

Pedestrian

APPEARANCE

Edge Detail - Rounded

Surface Texture - Smooth

Joint Spacing - 4 mm

TECHNICAL INFORMATION

Conforms to ASTM C 936

LEED Eligible - EPD's & HPD's available

			XL	SMALL RECTANGLE
Bundle Type	RANDOM		SINGLE	SINGLE
Plant Produced	MARENGO		MARENGO	MARENGO
Thickness (mm)	60 mm		60 mm	60 mm

SQFT PER	Stone	-	5.83	0.78
	Layer	11.66	11.66	11.66
	Bundle	116.57	116.57	116.57

PER BUNDLE	Layers	10.00	10.00	10.00
------------	--------	-------	-------	-------

SOLDIER LNFT PER	SqFt	-	0.32	0.80
	Layer	-	3.74	9.35
	Bundle	-	37.40	93.50

SAILOR LNFT PER	SqFt	0.80	0.53	1.60
	Layer	9.35	6.23	18.70
	Bundle	93.50	62.30	187.01

UNITS PER	SqFt	-	0.17	1.29
	Layer	8.00	2.00	15.00
	Bundle	80.00	20.00	150.00

LBS PER	Unit	-	160	21
	Layer	320	320	326
	Bundle	3,220	3,206	3,264

Colors	Reflectance	Stock	Stock	Stock
Bavarian Blend	SR n/a SRI n/a	✓	✓	-
Fossil	SR .22 SRI 21	✓	✓	-
Granite Fusion	SR .28 SRI 29	✓	✓	-
Ivory	SR n/a SRI n/a	-	-	✓
Dark Charcoal	SR n/a SRI n/a	-	-	✓

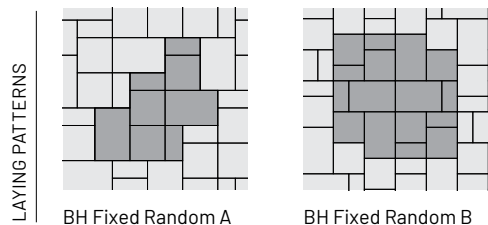

SMALL RECTANGLE
380 x 190 x 60mm
15 x 7 1/2 x 2 3/8"
150 Units/Bundle
.78 Sq.Ft./Stone

SOLD SEPARATELY

XL UNIT
950 x 570 x 60mm
37 1/2 x 22 1/2 x 2 3/8"
20 Units/Bundle
5.83 Sq.Ft./Stone

3 UNIT RANDOM BUNDLE

LARGE RECTANGLE **SQUARE** **SMALL RECTANGLE**
380 x 570 x 60mm 380 x 380 x 60mm 380 x 190 x 60mm
15 x 22 1/2 x 2 3/8" 15 x 15 x 2 3/8" 15 x 7 1/2 x 2 3/8"
20 Units/Bundle 30 Units/Bundle 30 Units/Bundle
2.33 SqFt./Stone 1.55 Sq.Ft./Stone .78 Sq.Ft./Stone

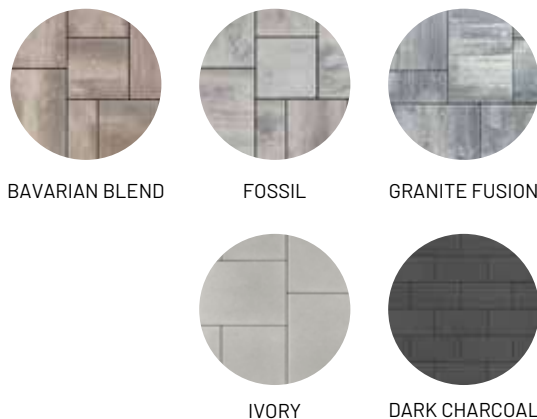

Notes: **SOLD IN FULL BUNDLES ONLY** and is produced and sold on a required, refundable skid. **This product is not intended for vehicular applications. Important: A urethane rubber paver mat must be used to prevent scuffing when compacting.** All measurements are nominal. Contact Unilock for more information. **STOCKED AT AURORA, ELKHORN, MARENGO & TONGANOXIE**



APPLICATIONS

Pedestrian

APPEARANCE

Edge Detail - Rounded

Surface Texture - Smooth

Joint Spacing - 4 mm

TECHNICAL INFORMATION

Conforms to ASTM C 936

LEED Eligible - EPD's & HPD's available

			XL
Bundle Type	RANDOM		SINGLE
Plant Produced	MARENGO		MARENGO
Thickness (mm)	60 mm		60 mm

SQFT PER	Stone	-	5.83
	Layer	11.66	11.66
	Bundle	116.57	116.57





PER BUNDLE	Layers	10.00	10.00
------------	--------	-------	-------

SOLDIER LNFT PER	SqFt	-	0.32
	Layer	-	3.74
	Bundle	-	37.40

SAILOR LNFT PER	SqFt	0.80	0.53
	Layer	9.35	6.23
	Bundle	93.50	62.30

UNITS PER	SqFt	-	0.17
	Layer	8.00	2.00
	Bundle	80.00	20.00

LBS PER	Unit	-	164
	Layer	319	329
	Bundle	3,195	3,292

Colors	Reflectance	Stock	Stock
Oat Beige 	SR .32 SRI 34	✓	✓
Opal Blend 	SR .39 SRI 44	✓	✓
Platinum 	SR .30 SRI 32	✓	✓
Biscotti 	SR n/a SRI n/a	✓	✓



OAT BEIGE



OPAL BLEND



PLATINUM



BISCOTTI

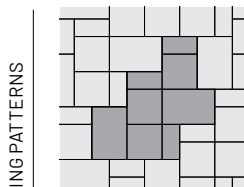

BH Fixed Random A

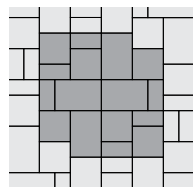

BH Fixed Random B

3 UNIT RANDOM BUNDLE

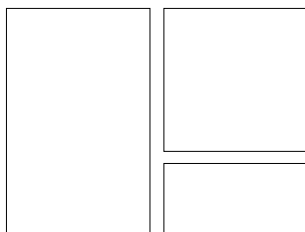

LARGE RECTANGLE
380 x 570 x 60mm
15 x 22 1/2 x 2 3/8"
20 Units/Bundle
2.33 Sq.Ft./Stone

SQUARE
380 x 380 x 60mm
15 x 15 x 2 3/8"
30 Units/Bundle
1.55 Sq.Ft./Stone

SMALL RECTANGLE
380 x 190 x 60mm
15 x 7 1/2 x 2 3/8"
30 Units/Bundle
.78 Sq.Ft./Stone

SOLD SEPARATELY



XL UNIT
950 x 570 x 60mm
37 1/2 x 22 1/2 x 2 3/8"
20 Units/Bundle
5.83 Sq.Ft./Stone

Notes: SOLD IN FULL BUNDLES ONLY and is produced and sold on a required, refundable skid. **This product is not intended for vehicular applications. Important: A urethane rubber paver mat must be used to prevent scuffing when compacting.** All measurements are nominal. Contact Unilock for more information. **STOCKED AT AURORA, ELKHORN, MARENGO & TONGANOXIE**



APPLICATIONS

Pedestrian, Light Vehicular, Roadway Street, Heavy-duty

APPEARANCE

Edge Detail - Rounded
 Surface Texture - Smooth
 Joint Spacing - 3 mm

TECHNICAL INFORMATION

Conforms to ASTM C 936
 LEED Eligible
 EPD's & HPD's available

Bundle Type	RANDOM
Plant Produced	MARENGO
Thickness (mm)	80 mm

SQFT PER	Stone	1.46
	Layer	11.66
	Section	-
	Bundle	81.60

PER BUNDLE	Layers	7.00
	Sections	-

SOLDIER LNFT PER	SqFt	-
	Layer	-
	Section	-
	Bundle	-

SAILOR LNFT PER	SqFt	0.80
	Layer	9.35
	Section	-
	Bundle	65.45

UNITS PER	SqFt	0.69
	Layer	8.00
	Section	-
	Bundle	56.00

LBS PER	Unit	53
	Section	-
	Layer	426
	Bundle	2,982

Colors	Reflectance	Stock
Custom Colors	SR n/a SRI n/a	SO

Please contact your local Sales Representative for color options.

LAYER CONFIGURATION

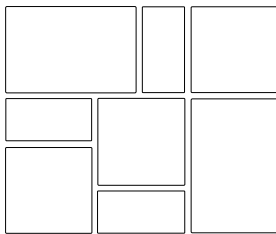

LAYING PATTERNS

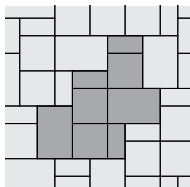

BH Fixed Random A

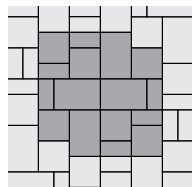

BH Fixed Random B

RANDOM BUNDLE

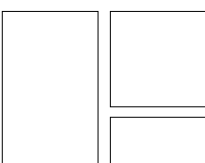

LARGE RECTANGLE
 380 x 570 x 80mm
 15 x 22 1/2 x 3 1/8"
 14 Units/Bundle
 2.08 SqFt/Stone

SQUARE
 380 x 380 x 80mm
 15 x 15 x 3 1/8"
 21 Units/Bundle
 1.39 Sq.Ft./Stone

SMALL RECTANGLE
 380 x 190 x 80mm
 15 x 7 1/2 x 3 1/8"
 21 Units/Bundle
 .69 Sq.Ft./Stone

Notes: Special Order (SO), Lead time required. Minimum quantities apply. **SOLD IN FULL BUNDLES ONLY** and is produced and sold on a required, refundable skid. **Important: A urethane rubber paver mat must be used to prevent scuffing when compacting.** All measurements are nominal. Contact Unilock for more information. **STOCKED AT AURORA, ELKHORN, MARENGO & TONGANOXIE**



APPLICATIONS

Pedestrian

APPEARANCE

Edge Detail - Zero

Surface Texture - Textured

Joint Spacing - 3 mm

TECHNICAL INFORMATION

Conforms to ASTM C 936

LEED Eligible

EPD's & HPD's available

			XL UNIT
	Bundle Type	RANDOM	SINGLE
	Plant Produced	MARENGO	MARENGO
	Thickness (mm)	60 mm	60 mm

SQFT PER	Stone	-	5.83
	Layer	11.66	11.66
	Bundle	116.57	116.57

PER BUNDLE	Layers	10.00	10.00
------------	--------	-------	-------

SOLDIER LNFT PER	SqFt	-	0.32
	Layer	-	3.74
	Bundle	-	37.40

SAILOR LNFT PER	SqFt	0.80	0.53
	Layer	9.35	6.23
	Bundle	93.50	62.30

UNITS PER	SqFt	-	0.17
	Layer	8.00	2.00
	Bundle	80.00	20.00

LBS PER	Unit	-	161
	Layer	330	321
	Bundle	3,253	3,215

Colors	Reflectance	Stock	Stock
Bavarian	SR n/a SRI n/a	✓	✓
Biscotti	SR n/a SRI n/a	✓	✓
Fossil	SR .22 SRI 21	✓	✓
Steel Mountain	SR n/a SRI n/a	✓	✓

LAYER CONFIGURATION

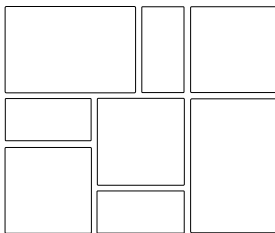

LAYING PATTERNS

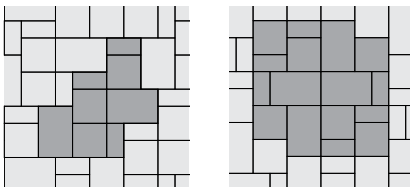

BV Fixed Random A

BV Fixed Random B

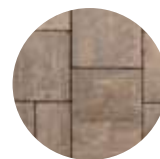

BAVARIAN

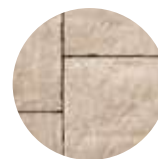

BISCOITI

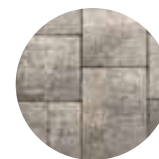

FOSSIL



STEEL MOUNTAIN

3 UNIT RANDOM BUNDLE

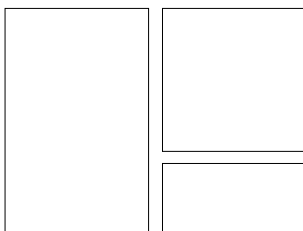

LARGE RECTANGLE
380 x 570 x 60mm
15 x 22 1/2 x 2 3/8"
20 Units/Bundle
2.08 SqFt./Stone

SQUARE
380 x 380 x 60mm
15 x 15 x 2 3/8"
30 Units/Bundle
1.39 Sq.Ft./Stone

SMALL RECTANGLE
380 x 190 x 60mm
15 x 7 1/2 x 2 3/8"
30 Units/Bundle
.69 Sq.Ft./Stone

SINGLE UNIT



XL UNIT
950 x 570 x 60mm
37 1/2 x 22 1/2 x 2 3/8"
20 Units/Bundle
5.83 Sq.Ft./Stone

Notes: SOLD IN FULL BUNDLES ONLY and is produced and sold on a required, refundable skid. This product is not intended for vehicular applications. Important: A urethane rubber paver mat must be used to prevent scuffing when compacting. All measurements are nominal. Contact Unilock for more information. STOCKED AT AURORA, ELKHORN, MARENGO & TONGANOXIE



APPLICATIONS

Pedestrian, Light Vehicular, Roadway Street, Heavy-duty

APPEARANCE

Edge Detail - Zero

Surface Texture - Textured

Joint Spacing - 3 mm

TECHNICAL INFORMATION

Conforms to ASTM C 936

LEED Eligible

EPD's & HPD's available

Bundle Type	RANDOM
Plant Produced	MARENCO
Thickness (mm)	80 mm

SQFT PER	Stone	1.46
	Layer	11.66
	Bundle	81.60

PER BUNDLE	Layers	7.00
------------	--------	------

SOLDIER LNFT PER	SqFt	-
	Layer	-
	Bundle	-

SAILOR LNFT PER	SqFt	0.80
	Layer	9.35
	Bundle	65.45

UNITS PER	SqFt	0.69
	Layer	8.00
	Bundle	56.00

LBS PER	Unit	52
	Layer	418
	Bundle	2,925

Colors	Reflectance	Stock
Bavarian	SR n/a SRI n/a	SO
Biscotti	SR n/a SRI n/a	SO
Fossil	SR n/a SRI n/a	SO
Steel Mountain	SR n/a SRI n/a	SO

LAYER CONFIGURATION

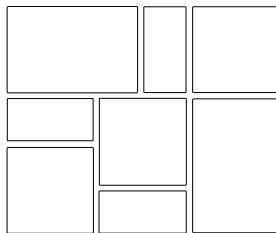

LAYING PATTERNS

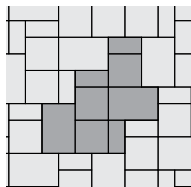

BV Fixed Random A

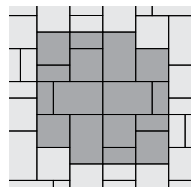

BV Fixed Random B



BAVARIAN

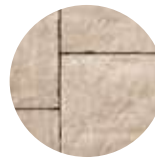

BISCOTTI



FOSSIL



STEEL MOUNTAIN

3 UNIT RANDOM BUNDLE

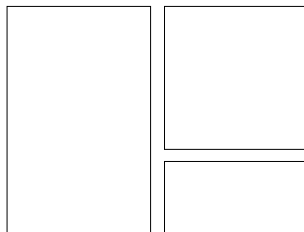

LARGE RECTANGLE
380 x 570 x 80mm
15 x 22 1/2 x 3 1/8"
14 Units/Bundle
2.08 SqFt./Stone

SQUARE
380 x 380 x 80mm
15 x 15 x 3 1/8"
21 Units/Bundle
1.39 Sq.Ft./Stone

SMALL RECTANGLE
380 x 190 x 80mm
15 x 7 1/2 x 3 1/8"
21 Units/Bundle
.69 Sq.Ft./Stone

Notes: Special Order (SO), Lead time required. Minimum quantities apply. **SOLD IN FULL BUNDLES ONLY** and is produced and sold on a required, refundable skid. **Important:** A urethane rubber paver mat must be used to prevent scuffing when compacting. All measurements are nominal. Contact Unilock for more information. **STOCKED AT AURORA, ELKHORN, MARENCO & TONGANOXIE**

Brussels Block®



APPLICATIONS

Pedestrian, Light Vehicular

APPEARANCE

Edge Detail - Zero

Surface Texture - Weathered

Joint Spacing - 2 mm

TECHNICAL INFORMATION

Conforms to ASTM C 936

LEED Eligible

EPD's & HPD's available

	HALF	STANDARD	XL
Bundle Type	SINGLE	SINGLE	SINGLE
Plant Produced	ELKHORN / CHICAGO		
Thickness (mm)	70 mm	70 mm	70 mm

SQFT PER	Stone	0.20	0.40	0.80
	Layer	11.09	11.86	9.57
	Bundle	88.70	94.91	95.70

PER BUNDLE	Layers	8.00	8.00	10.00
------------	--------	------	------	-------

SOLDIER LNFT PER	SqFt	1.72	1.44	0.86
	Layer	19.11	17.03	8.19
	Bundle	152.86	136.22	81.89

SAILOR LNFT PER	SqFt	2.87	1.73	1.43
	Layer	31.78	20.47	13.70
	Bundle	254.28	163.78	137.01

UNITS PER	SqFt	5.05	2.53	1.25
	Layer	56.00	30.00	12.00
	Bundle	448.00	240.00	120.00

LBS PER	Unit	6	13	26
	Layer	358	389	311
	Bundle	2,865	3,110	3,112

Colors	Reflectance	Stock	Stock	Stock
Limestone	SR .28 SRI 29	✓	✓	✓
River	SR .32 SRI 34	✓	✓	✓
Sandstone	SR .41 SRI 46	✓	✓	✓
Sierra	SR n/a SRI n/a	✓	✓	✓

LAYER CONFIGURATION

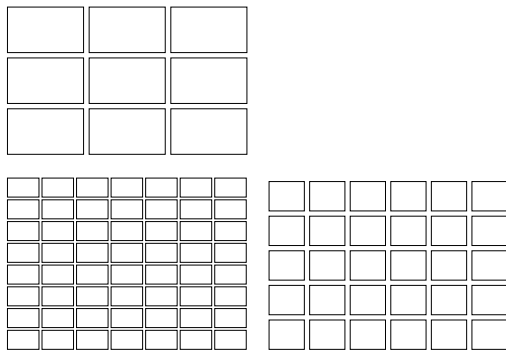

LAYING PATTERNS

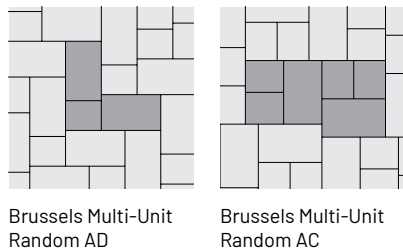

SINGLE UNITS

HALF
104 x 173 x 70mm
4 x 6 7/8 x 2 3/4"
448 Units/Bundle
.20 Sq.Ft./Stone

STANDARD
173 x 208 x 70mm
6 7/8 x 8 1/4 x 2 3/4"
240 Units/Bundle
.40 Sq.Ft./Stone

XL
208 x 348 x 70mm
8 1/4 x 13 3/4 x 2 3/4"
120 Units/Bundle
.80 Sq.Ft./Stone

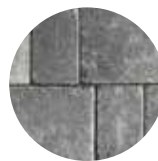

LIMESTONE



RIVER



SANDSTONE



SIERRA

Notes: Important: A urethane rubber paver mat must be used to prevent scuffing when compacting. All measurements are nominal. Contact Unilock for more information. STOCKED AT AURORA, ELKHORN & TONGANOXIE



APPLICATIONS

Pedestrian, Light Vehicular, Border/Accents

APPEARANCE

Edge Detail - Rounded
 Surface Texture - Textured
 Joint Spacing - 3 mm

TECHNICAL INFORMATION

Conforms to ASTM C 936
 LEED Eligible
 EPD's & HPD's available

Bundle Type	SINGLE
Plant Produced	AYR
Thickness (mm)	60 mm

SQFT PER	Stone	0.15
	Layer	11.15
	Bundle	89.20

PER BUNDLE	Layers	8.00
------------	--------	------

SOLDIER LNFT PER	SqFt	1.43
	Layer	15.99
	Bundle	127.95

SAILOR LNFT PER	SqFt	4.41
	Layer	49.21
	Bundle	393.70

UNITS PER	SqFt	6.73
	Layer	75.00
	Bundle	600.00

LBS PER	Unit	4
	Layer	294
	Bundle	2,349

Colors	Reflectance	Stock
Arctic Grey	SR .49 SRI 57	✓
Basalt	SR n/a SRI n/a	✓
Burgundy Red	SR .35 SRI 38	✓
Burnt Clay	SR .36 SRI 40	✓
Old Oak	SR .37 SRI 41	✓
Steel Blue	SR n/a SRI n/a	✓

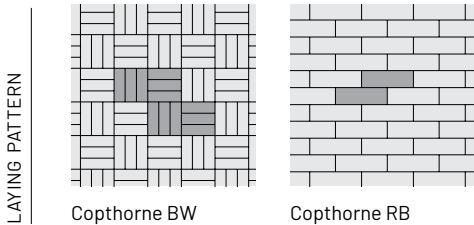

SINGLE UNIT

	STANDARD 65 x 200 x 60mm 2 5/8 x 7 7/8 x 2 3/8" 600 Units/Bundle .15 SqFt/Stone
--	--

Notes: **SOLD IN FULL BUNDLES ONLY** and is produced and sold on a required, refundable skid. *Colors are sold separately. **Important: A urethane rubber paver mat must be used to prevent scuffing when compacting.** All measurements are nominal. Please refer to the Polymeric Sand Best Practices on Page 93. Contact Unilock for more information. **STOCKED AT AURORA, ELKHORN & TONGANOXIE**



APPLICATIONS

Pedestrian, Light Vehicular, Border/Accents

APPEARANCE

Edge Detail - Rounded
 Surface Texture - Textured
 Joint Spacing - 15 mm

TECHNICAL INFORMATION

Conforms to ASTM C 936
 LEED Eligible
 EPD's & HPD's available

Bundle Type	RANDOM
Plant Produced	AYR
Thickness (mm)	60 mm

SQFT PER	Stone	-
	Layer	12.29
	Bundle	98.30

PER BUNDLE	Layers	8.00
------------	--------	------

SOLDIER LNFT PER	SqFt	-
	Layer	-
	Bundle	-

SAILOR LNFT PER	SqFt	2.25
	Layer	27.69
	Bundle	221.52

UNITS PER	SqFt	-
	Layer	48.00
	Bundle	384.00

LBS PER	Unit	-
	Layer	291
	Bundle	2,326

Colors	Reflectance	Stock
Basalt	SR n/a SRI n/a	✓
Belgian Blue	SR n/a SRI n/a	✓
Dawn Mist	SR .37 SRI 41	✓
Pebble Taupe	SR .38 SRI 42	✓

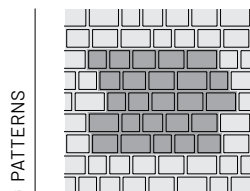

Courtstone Fixed Random

5 UNIT RANDOM BUNDLE



XL RECTANGLE
 215 x 130 x 60mm
 8 3/8 x 5 1/8 x 2 3/8"
 128 Units/Bundle
 .30 SqFt/Stone

LARGE RECTANGLE
 185 x 130 x 60mm
 7 1/4 x 5 1/8 x 2 3/8"
 64 Units/Bundle
 .28 SqFt/Stone

RECTANGLE
 165 x 130 x 60mm
 6 1/2 x 5 1/8 x 2 3/8"
 64 Units/Bundle
 .23 SqFt/Stone

SMALL RECTANGLE
 145 x 130 x 60mm
 5 3/4 x 5 1/8 x 2 3/8"
 64 Units/Bundle
 .20 SqFt/Stone

SQUARE
 130 x 130 x 60mm
 5 1/8 x 5 1/8 x 2 3/8"
 64 Units/Bundle
 .18 SqFt/Stone



Notes: **SOLD IN FULL BUNDLES ONLY** and is produced and sold on a required, refundable skid. *Colors are sold separately. **Important: A urethane rubber paver mat must be used to prevent scuffing when compacting.** All measurements are nominal. Please refer to the Polymeric Sand Best Practices on Page 93. Contact Unilock for more information. **STOCKED AT AURORA, ELKHORN & TONGANOXIE.**



APPLICATIONS

Pedestrian, Light Vehicular, Roadway Street, Heavy-duty, Permeable

APPEARANCE

Edge Detail - Umbriano- Rounded
Surface Texture - Umbriano/Mottled
Joint Spacing - 10 mm

TECHNICAL INFORMATION

Conforms to ASTM C 936
LEED Eligible
EPD's & HPD's available

	8 x 8
Bundle Type	SINGLE
Plant Produced	MARENGO
Thickness (mm)	60 mm

SQFT PER	Stone	0.45
	Layer	10.83
	Bundle	108.31

PER BUNDLE	Layers	10.00
------------	--------	-------

SOLDIER LNFT PER	SqFt	-
	Layer	-
	Bundle	-

SAILOR LNFT PER	SqFt	-
	Layer	-
	Bundle	-

UNITS PER	SqFt	2.22
	Layer	24.00
	Bundle	240.00

LBS PER	Unit	12
	Layer	276
	Bundle	2,762

Colors	Reflectance	Stock
French Grey	SR .18 SRI 17	✓
Midnight Sky	SR .17 SRI 15	✓
Winter Marvel	SR .35 SRI 38	✓

LAYER CONFIGURATION

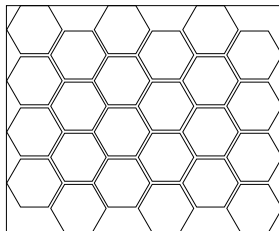

LAYING PATTERNS

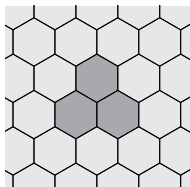

Hex Paver

SINGLE UNIT

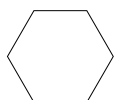

8 x 8
205 x 205 x 60mm
7 7/8 x 7 7/8 x 2 3/8"
240 Units/Bundle
.45 SqFt/Stone

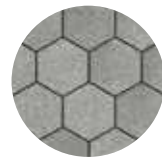

FRENCH GREY



MIDNIGHT SKY

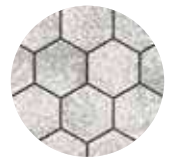

WINTER MARVEL

Notes: **SOLD IN FULL BUNDLES ONLY** and is produced and sold on a required, refundable skid. **Important: A urethane rubber paver mat must be used to prevent scuffing when compacting.** All measurements are nominal. Contact Unilock for more information. STOCKED AT AURORA, ELKHORN, MARENGO & TONGANOXIE



APPLICATIONS

Pedestrian, Light Vehicular, Roadway Street,
Heavy-duty, Permeable

APPEARANCE

Edge Detail - Micro
Surface Texture - Custom (see below)
Umbriano Mottled / Il Campo Brushed
Joint Spacing - 6.25 mm
Void - 5.8%

TECHNICAL INFORMATION

Conforms to ASTM C 936
LEED Eligible
EPD's & HPD's available

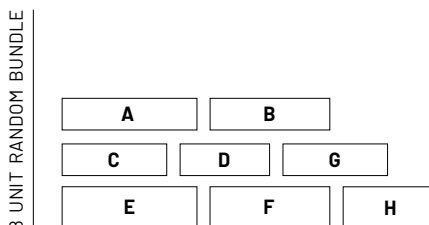
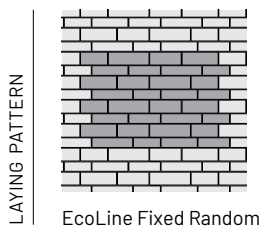
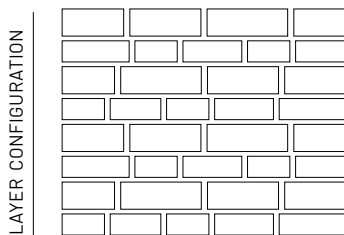

UNIT A 357 x 84 x 100mm 14 x 3 3/8 x 3 7/8" 20 Units/Bundle .32 SqFt/Stone	UNIT B 317 x 84 x 100mm 12 1/2 x 3 3/8 x 3 7/8" 20 Units/Bundle .29 SqFt/Stone	UNIT C 277 x 84 x 100mm 10 7/8 x 3 3/8 x 3 7/8" 20 Units/Bundle .25 SqFt/Stone	UNIT D 237 x 84 x 100mm 9 3/8 x 3 3/8 x 3 7/8" 20 Units/Bundle .21 SqFt/Stone
UNIT E 357 x 114 x 100mm 14 x 4 1/2 x 3 7/8" 20 Units/Bundle .44 SqFt/Stone	UNIT F 317 x 114 x 100mm 12 1/2 x 4 1/2 x 3 7/8" 20 Units/Bundle .39 SqFt/Stone	UNIT G 277 x 114 x 100mm 10 7/8 x 4 1/2 x 3 7/8" 20 Units/Bundle .34 SqFt/Stone	UNIT H 237 x 114 x 100mm 9 3/8 x 4 1/2 x 3 7/8" 20 Units/Bundle .29 SqFt/Stone

Bundle Type	RANDOM
Plant Produced	CHICAGO
Thickness (mm)	100 mm

SQFT PER	Stone	-
	Layer	11.03
	Bundle	55.17

PER BUNDLE	Layers	5.00
------------	--------	------

SOLDIER LNFT PER	SqFt	-
	Layer	-
	Bundle	-

SAILOR LNFT PER	SqFt	-
	Layer	-
	Bundle	-





UNITS PER	SqFt	-
	Layer	32.00
	Bundle	160.00

LBS PER	Unit	-
	Layer	513
	Bundle	2,564

Colors	Reflectance	Stock
Custom Colors & Finishes	SR n/a SRI n/a	SO

Please contact your local Sales Representative for color options.

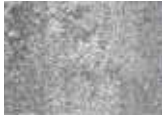
FINISH

 CLASSIC Thrux Finish	 IL CAMPO® Brushed Finish	 SERIES™ Exposed Granite Finish
 SMOOTH Premier Finish	 UMBRIANO® Mottled Finish with/ ColorFusion and EasyClean	

Notes: Special Order (SO), Lead time required. Minimum quantities apply. SOLD IN FULL BUNDLES ONLY and is produced and sold on a required, refundable skid. Important: A urethane rubber paver mat must be used to prevent scuffing when compacting on textured surfaces. All measurements are nominal. Please note that weights are only estimated as custom finishes will alter bundle weight. Contact Unilock for more information.



APPLICATIONS

Pedestrian, Light Vehicular, Roadway Street,
Heavy-duty, Permeable

APPEARANCE

Edge Detail - Chamfer
Surface Texture - Custom (see below)
Umbriano Mottled / Il Campo Brushed
Joint Spacing - 7 mm
Void - 7.3%

TECHNICAL INFORMATION

Conforms to ASTM C 936
LEED Eligible
EPD's & HPD's available

LAYER CONFIGURATION

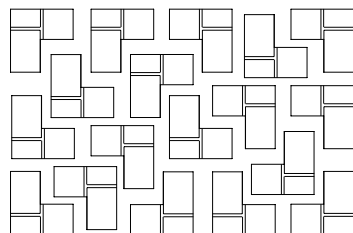

LAYING PATTERN

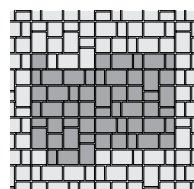

EcoOptiloc Cluster

SINGLE UNITS

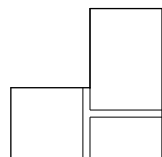

STANDARD
250 x 250 x 80mm
9 7/8" x 9 7/8" x 3 1/8"
168 Units/Bundle
.50 SqFt/Stone

	ALL FINISHES
Bundle Type	SINGLE
Plant Produced	MULTI-PLANT
Thickness (mm)	80 mm

SQFT PER	Stone	0.50
	Layer	10.60
	Bundle	84.80

PER BUNDLE	Layers	8.00
------------	--------	------

SOLDIER LNFT PER	SqFt	-
	Layer	-
	Bundle	-

SAILOR LNFT PER	SqFt	-
	Layer	-
	Bundle	-

UNITS PER	SqFt	1.98
	Layer	21.00
	Bundle	168.00

LBS PER	Unit	17
	Layer	358
	Bundle	2,860

Colors	Reflectance	Stock
Custom Colors & Finishes	SR n/a SRI n/a	SO

Please contact your local Sales Representative for color options.



CLASSIC
Thrumix Finish



IL CAMPO®
Brushed Finish



SERIES™
Exposed Granite Finish



SMOOTH
Premier Finish



UMBRIANO®
Mottled Finish with/
ColorFusion and EasyClean

FINISH

Notes: **Special Order (SO), Lead time required.** Minimum quantities apply. **SOLD IN FULL BUNDLES ONLY** and is produced and sold on a required, refundable skid. **Important: A urethane rubber paver mat must be used to prevent scuffing when compacting on textured surfaces.** All measurements are nominal. **Please note that weights are only estimated as custom finishes will alter bundle weight.** Contact Unilock for more information.



APPLICATIONS

Pedestrian, Light Vehicular, Roadway Street,
Heavy-duty , Permeable

APPEARANCE

Edge Detail - Micro
Surface Texture - Smooth
Joint Spacing - 7 mm
Void - 4.6-7.08%

TECHNICAL INFORMATION

Conforms to ASTM C 936
LEED Eligible
EPD's & HPD's available

	5 x 10
Bundle Type	SINGLE
Plant Produced	MULTI-PLANT
Thickness (mm)	80 mm

SQFT PER	Stone	0.31
	Layer	10.85
	Bundle	75.95

PER BUNDLE	Layers	7.00
------------	--------	------

SOLDIER LNFT PER	SqFt	1.27
	Layer	13.78
	Bundle	96.46

SAILOR LNFT PER	SqFt	2.54
	Layer	27.56
	Bundle	192.91

UNITS PER	SqFt	3.23
	Layer	35.00
	Bundle	245.00

LBS PER	Unit	11
	Layer	381
	Bundle	2,669

Colors	Reflectance	Stock
River	SR .32 SRI 34	✓
Sierra	SR n/a SRI n/a	✓

LAYER CONFIGURATION

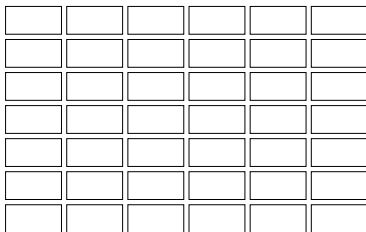

LAYING PATTERNS

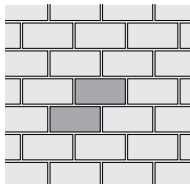

EcoPriora 5x10 RB

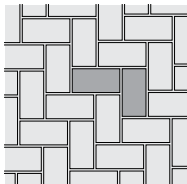

EcoPriora 5x10 HB

SINGLE UNITS



5 x 10
120 x 240 x 80mm
4 ¾ x 9 ½ x 3 ⅛
245 Units/Bundle
.31 Sq.Ft./Stone



RIVER



SIERRA

Notes: SOLD IN FULL BUNDLES ONLY and is produced and sold on a required, refundable skid. **Important: A urethane rubber paver mat must be used to prevent scuffing when compacting on textured surfaces.** All measurements are nominal. Contact Unilock for more information. **STOCKED AT AURORA, ELKHORN & TONGANOXIE**



APPLICATIONS

Pedestrian, Light Vehicular, Roadway Street,
Heavy-duty, Permeable

APPEARANCE

Edge Detail - Micro
Surface Texture - Smooth
Joint Spacing - 7 mm
Void - 4.6 - 7.08%

TECHNICAL INFORMATION

Conforms to ASTM C 936
LEED Eligible
EPD's & HPD's available

		5 x 10	
Bundle Type		SINGLE	
Plant Produced		CHICAGO	
Thickness (mm)		80 mm	
SQFT PER	Stone	0.31	
	Layer	10.85	
	Bundle	75.95	
PER BUNDLE	Layers	7.00	
SOLDIER LNFT PER	SqFt	1.27	
	Layer	13.78	
	Bundle	96.46	
SAILOR LNFT PER	SqFt	2.54	
	Layer	27.56	
	Bundle	192.91	
UNITS PER	SqFt	3.23	
	Layer	35.00	
	Bundle	245.00	
LBS PER	Unit	11	
	Layer	388	
	Bundle	2,717	
Colors		Reflectance	Stock
Granite	SR .26 SRI 27		✓
Sierra	SR n/a SRI n/a		✓

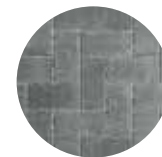

GRANITE



SIERRA

LAYING PATTERNS

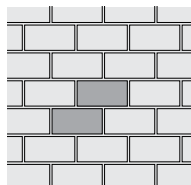

EcoPriora 5x10 RB

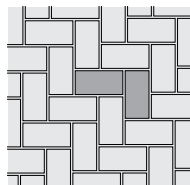

EcoPriora 5x10 HB

SINGLE UNITS



5 x 10
120 x 240 x 80mm
4 ¾ x 9 ½ x 3 ⅛
245 Units/Bundle
.31 Sq.Ft./Stone

Notes: **SOLD IN FULL BUNDLES ONLY** and is produced and sold on a required, refundable skid. **Important: A urethane rubber paver mat must be used to prevent scuffing when compacting on textured surfaces.** All measurements are nominal. Contact Unilock for more information. **STOCKED AT AURORA, ELKHORN & TONGANOXIE**



APPLICATIONS

Pedestrian, Light Vehicular

APPEARANCE

Edge Detail - Rounded
 Surface Texture - Shot Blasted
 Joint Spacing - 7 mm
 Void - 8.6%

TECHNICAL INFORMATION

Conforms to ASTM C 936
 Eligible for LEED v4.1 credits

	4 x 12
Bundle Type	SINGLE
Plant Produced	ONTARIO
Thickness (mm)	80 mm

SQFT PER	Stone	0.32
	Layer	11.63
	Bundle	81.38

PER BUNDLE	Layers	7.00
------------	--------	------

SOLDIER LNFT PER	SqFt	1.02
	Layer	11.81
	Bundle	82.68

SAILOR LNFT PER	SqFt	3.05
	Layer	35.43
	Bundle	248.03

UNITS PER	SqFt	3.10
	Layer	36.00
	Bundle	252.00

LBS PER	Unit	12
	Layer	425
	Bundle	2,978

Colors	Reflectance	Stock
Light Opal Blend	SR n/a SRI n/a	✓
Light Steel Grey	SR n/a SRI n/a	✓

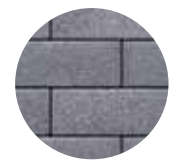
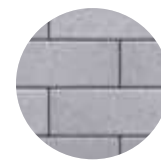

LIGHT OPAL BLEND

LIGHT STEEL GREY

LAYING PATTERNS

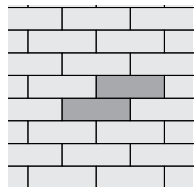

Eco-Promenade
4x12 RB

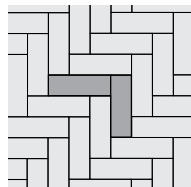

Eco-Promenade
4x12 HB

SINGLE UNIT



4 x 12
 100 x 300 x 80mm
 3 7/8 x 11 7/8 x 3 1/8"
 252 units/Bundle
 .32 Sq.Ft./Stone

Notes: **Special Order (SO), Lead time required.** Minimum quantities apply. **SOLD IN FULL BUNDLES ONLY** and is produced and sold on a required, refundable skid. **Important: A urethane rubber paver mat must be used to prevent scuffing when compacting on textured surfaces.** All measurements are nominal. Contact Unilock for more information.



APPLICATIONS

Pedestrian, Light Vehicular, Roadway Street,
Heavy-duty, Permeable

APPEARANCE

Edge Detail - Rounded Bevel Edge
Surface Texture - Series Exposed
Joint Spacing - 7 mm
Void - 8.6%

TECHNICAL INFORMATION

Conforms to ASTM C 936
LEED Eligible
EPD's & HPD's available

	4 x 12
Bundle Type	SINGLE
Plant Produced	CHICAGO
Thickness (mm)	80 mm

SQFT PER	Stone	0.32
	Layer	11.63
	Bundle	93.04

PER BUNDLE	Layers	8.00
------------	--------	------

SOLDIER LNFT PER	SqFt	1.02
	Layer	11.81
	Bundle	94.49

SAILOR LNFT PER	SqFt	3.05
	Layer	35.43
	Bundle	283.46

UNITS PER	SqFt	3.10
	Layer	36.00
	Bundle	288.00

LBS PER	Unit	12
	Layer	426
	Bundle	3,404

Colors	Reflectance	Stock
Arctic Grey	SR n/a SRI n/a	✓
Nordic Star	SR n/a SRI n/a	✓

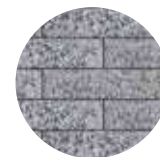

ARCTIC GREY

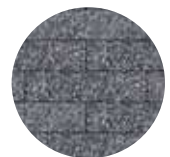

NORDIC STAR

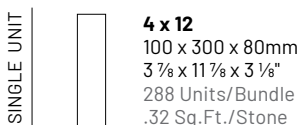
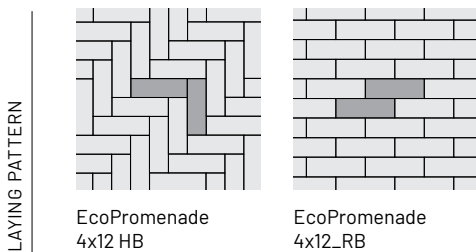

Notes: **SOLD IN FULL BUNDLES ONLY** and is produced and sold on a required, refundable skid. **Important: A urethane rubber paver mat must be used to prevent scuffing when compacting on textured surfaces.** All measurements are nominal. Contact Unilock for more information. **STOCKED AT AURORA, ELKHORN & TONGANOXIE**



APPLICATIONS

Pedestrian, Light Vehicular, Permeable

APPEARANCE

Edge Detail - Rounded

Surface Texture - Umbriano

Joint Spacing - 7 mm

TECHNICAL INFORMATION

Conforms to ASTM C 936

Eligible for LEED v4.1 credits

		4 x 12
	Bundle Type	SINGLE
	Plant Produced	MARENGO
	Thickness (mm)	80 mm

SQFT PER	Stone	0.32
	Layer	11.63
	Bundle	93.04

PER BUNDLE	Layers	8.00
------------	--------	------

SOLDIER LNFT PER	SqFt	1.02
	Layer	11.81
	Bundle	94.49

SAILOR LNFT PER	SqFt	3.05
	Layer	35.43
	Bundle	283.46

UNITS PER	SqFt	3.10
	Layer	36.00
	Bundle	288.00

LBS PER	Unit	12
	Layer	426
	Bundle	3,404

Colors	Reflectance	Stock
French Grey	SR .n/a SRI n/a	✓
Midnight Sky	SR .n/a SRI n/a	✓
Winter Marvel	SR .n/a SRI n/a	✓



FRENCH GREY



MIDNIGHT SKY



WINTER MARVEL

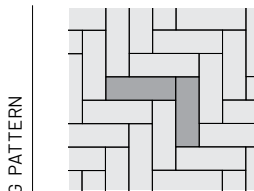

EcoPromenade
4x12 HB

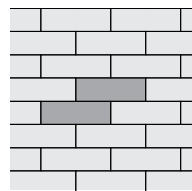

EcoPromenade
4x12 RB

SINGLE UNIT



4 x 12
100 x 300 x 80mm
3⁷/₈ x 11⁷/₈ x 3¹/₈"
288 Units/Bundle
0.32Sq.Ft./Stone

Notes: SOLD IN FULL BUNDLES ONLY and is produced and sold on a required, refundable skid. **Important: A urethane rubber paver mat must be used to prevent scuffing when compacting on textured surfaces.** All measurements are nominal. Contact Unilock for more information.



APPLICATIONS

Pedestrian, Light Vehicular, Borders and accents

APPEARANCE

Edge Detail - Rounded
 Surface Texture - Smooth
 Joint Spacing - 3 mm

TECHNICAL INFORMATION

Conforms to ASTM C 936
 LEED Eligible
 EPD's & HPD's available

	4 x 8	4 x 8
Bundle Type	SINGLE	SINGLE
Plant Produced	CHICAGO	CHICAGO
Thickness (mm)	60 mm	80 mm

SQFT PER	Stone	0.22	0.22
	Layer	11.80	11.80
	Bundle	118.00	82.60

PER BUNDLE	Layers	10.00	7.00
------------	--------	-------	------

SOLDIER LNFT PER	SqFt	1.50	1.50
	Layer	17.72	17.72
	Bundle	177.17	124.02

SAILOR LNFT PER	SqFt	3.00	3.00
	Layer	35.43	35.43
	Bundle	354.33	248.03

UNITS PER	SqFt	4.58	4.58
	Layer	54.00	54.00
	Bundle	540.00	378.00

LBS PER	Unit	6	8
	Layer	327	423
	Bundle	3,270	2,963

Colors	Reflectance	Stock	Stock
Charleston	SR n/a SRI 36	✓	SO
Dark Charcoal	SR n/a SRI n/a	✓	SO
Granite Blend	SR n/a SRI n/a	✓	SO
Heritage Brown	SR n/a SRI n/a	✓	SO
Ivory	SR n/a SRI n/a	✓	SO
River	SR .22 SRI 19	✓	SO
Sierra	SR n/a SRI n/a	✓	SO

LAYER CONFIGURATION

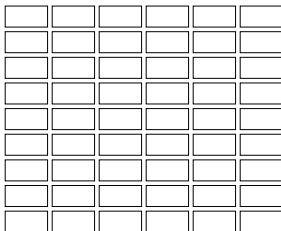

LAYING PATTERNS

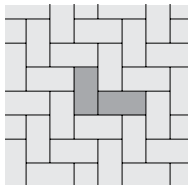

HollandPremier
4x8 RB

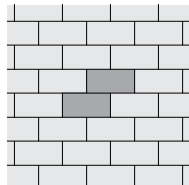

HollandPremier
4x8 HB

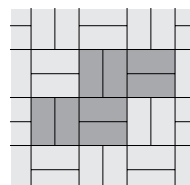

HollandPremier
4x8 BW

SINGLE UNIT

4 x 8
 100 x 200 x 60mm
 3 7/8 x 7 7/8 x 2 3/8"
 540 Units/Bundle
 .22 Sq.Ft./Stone

4 x 8
 100 x 200 x 80mm
 3 7/8 x 7 7/8 x 3 1/8"
 378 Units/Bundle
 .22 Sq.Ft./Stone



Notes: SOLD IN FULL BUNDLES ONLY and is produced and sold on a required, refundable skid. **Important: A urethane rubber paver mat must be used to prevent scuffing when compacting on textured surfaces.**
 All measurements are nominal. Contact Unilock for more information. **STOCKED AT AURORA, ELKHORN & TONGANOXIE**

Hollandstone™ 60mm



APPLICATIONS

Pedestrian, Light Vehicular

APPEARANCE

Edge Detail - Chamfer

Surface Texture - Smooth

Joint Spacing - 3 mm

TECHNICAL INFORMATION

Conforms to ASTM C 936

LEED Eligible

EPD's & HPD's available

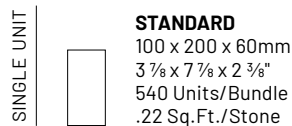
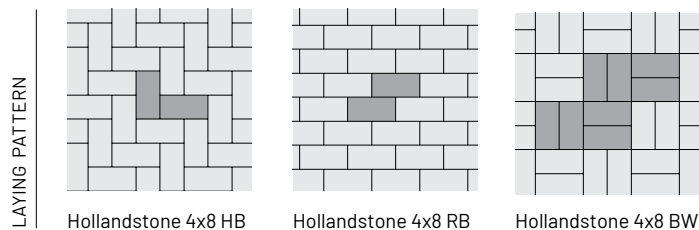
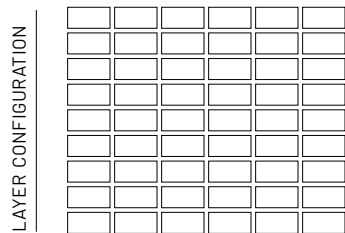

	4 x 8
Bundle Type	SINGLE
Plant Produced	CHICAGO
Thickness (mm)	60 mm

SQFT PER	Stone	0.22
	Layer	11.80
	Section	19.67
	Bundle	118.00

PER BUNDLE	Layers	10.00
	Sections	6.00

SOLDIER LNFT PER	SqFt	1.50
	Layer	17.72
	Section	29.53
	Bundle	177.17

SAILOR LNFT PER	SqFt	3.00
	Layer	35.43
	Section	59.06
	Bundle	354.33

UNITS PER	SqFt	4.58
	Layer	54.00
	Section	90.00
	Bundle	540.00

LBS PER	Unit	6
	Section	538
	Layer	323
	Bundle	3,229

Colors	Reflectance	Stock
Autumn Red	SR n/a SRI n/a	✓
Charcoal	SR .12 SRI 9	✓
River	SR .32 SRI 34	✓
Sierra	SR n/a SRI n/a	✓

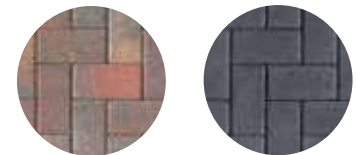

AUTUMN RED

CHARCOAL



RIVER

SIERRA

Important: A urethane rubber paver mat must be used to prevent scuffing when compacting on textured surfaces. All measurements are nominal. Contact Unilock for more information. **STOCKED AT AURORA, ELKHORN & TONGANOXIE**



APPLICATIONS

Pedestrian, Light Vehicular, Roadway Street, Heavy-duty

APPEARANCE

Edge Detail - Chamfer

Surface Texture - Smooth / Series Exposed

Umbriano Mottled / Il Campo Brushed

Joint Spacing - 3 mm

TECHNICAL INFORMATION

Conforms to ASTM C 936

LEED Eligible

EPD's & HPD's available

	4 x 8	HERRINGBONE
Bundle Type	SINGLE	SINGLE
Plant Produced	MULTI-PLANT	MULTI-PLANT
Thickness (mm)	80 mm	80 mm

SQFT PER	Stone	0.22	0.22
	Layer	11.80	11.80
	Bundle	82.60	82.60

PER BUNDLE	Layers	7.00	7.00
------------	--------	------	------

SOLDIER LNFT PER	SqFt	1.50	-
	Layer	17.72	-
	Bundle	124.02	-

SAILOR LNFT PER	SqFt	3.00	-
	Layer	35.43	-
	Bundle	248.03	-

UNITS PER	SqFt	4.58	4.58
	Layer	54.00	54.00
	Bundle	378.00	378.00

LBS PER	Unit	7.78	7.78
	Layer	368	368
	Bundle	2,944	2,944

Colors	Reflectance	Stock	Stock
Custom Colors & Finishes	SR n/a SRI n/a	SO	SO

Please contact your local Sales Representative for color options.

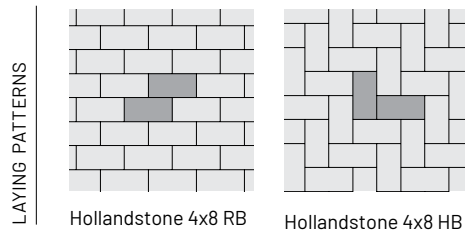
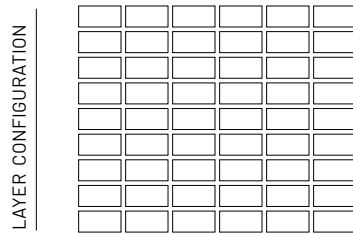

FINISH

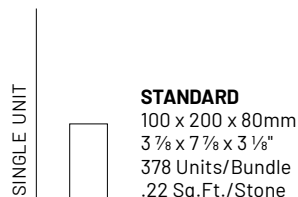

Notes: Special Order (SO), Lead time required. Minimum quantities apply. **SOLD IN FULL BUNDLES ONLY** and is produced and sold on a required, refundable skid. **Important: A urethane rubber paver mat must be used to prevent scuffing when compacting on textured surfaces.** All measurements are nominal. **Please note that weights are only estimated as custom finishes will alter bundle weight.** Contact Unilock for more information.



APPLICATIONS

Pedestrian, Light Vehicular

APPEARANCE

Edge Detail - Zero
 Surface Texture - Smooth
 Joint Spacing - 3 mm

TECHNICAL INFORMATION

Conforms to ASTM C 936
 LEED Eligible
 EPD's & HPD's available

	SMOOTH
Bundle Type	SINGLE
Plant Produced	CHICAGO
Thickness (mm)	60 mm

SQFT PER	Stone	0.16
	Layer	11.16
	Bundle	111.60

PER BUNDLE	Layers	10.00
------------	--------	-------

SOLDIER LNFT PER	SqFt	1.27
	Layer	14.17
	Bundle	141.73

SAILOR LNFT PER	SqFt	5.08
	Layer	56.69
	Bundle	566.92

UNITS PER	SqFt	6.45
	Layer	72.00
	Bundle	720.00

LBS PER	Unit	4.00
	Layer	297
	Bundle	2,965

Colors	Reflectance	Stock
Cocoa Brown	SR .34 SRI 37	✓
Dark Charcoal	SR n/a SRI n/a	✓
Granite Fusion	SR .28 SRI 29	✓
Sable Blend	SR .38 SRI 42	✓

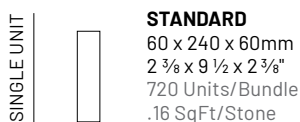
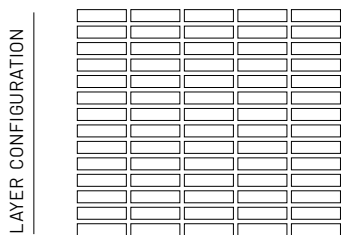

Notes: **SOLD IN FULL BUNDLES ONLY** and is produced and sold on a required, refundable skid. **Important: A urethane rubber paver mat must be used to prevent scuffing when compacting.** All measurements are nominal. Contact Unilock for more information.
 STOCKED AT AURORA, ELKHORN & TONGANOXIE

Natural Stone Slabs



APPLICATIONS

Pedestrian, Roof Deck

APPEARANCE

Edge Detail - Sawn

Surface Texture - Brushed / Riven

Joint Spacing - 10 mm

TECHNICAL INFORMATION

Visit Unilock.com for more information.

SANDSTONE		12 x 24	18 x 24	24 x 24	24 x 36
Bundle Type		SINGLE	SINGLE	SINGLE	SINGLE
Thickness (mm)		22 mm	22 mm	22 mm	22 mm

SQFT PER	Crate	180.00	186.00	160.00	180.00
	Units	2.00	3.00	4.00	6.00

UNITS PER	Crate	90.00	62.00	40.00	30.00
	SqFt	0.50	0.33	0.25	0.17

LBS PER	Unit	24	36	48	72
	Crate	2,033	2,136	1,836	2,072

Colors	Reflectance	Stock	Stock	Stock	Stock
Cascade	SR n/a SRI n/a	✓	✓	✓	✓
Greyfield	SR .32 SRI 35	✓	✓	✓	✓
Stone Cliff Grey	SR .27 SRI 28	✓	✓	✓	✓

LIMESTONE		12 x 24	18 x 24	24 x 24	24 x 36
Bundle Type		SINGLE	SINGLE	SINGLE	SINGLE
Thickness (mm)		22 mm	22 mm	22 mm	22 mm

SQFT PER	Crate	180.00	186.00	160.00	180.00
	Units	2.00	3.00	4.00	6.00

UNITS PER	Crate	90.00	62.00	40.00	30.00
	SqFt	0.50	0.33	0.25	0.17

LBS PER	Unit	24	36	48	72
	Crate	2,033	2,136	1,836	2,072

Colors	Reflectance	Stock	Stock	Stock	Stock
Black River	SR .08 SRI 4	✓	✓	✓	✓

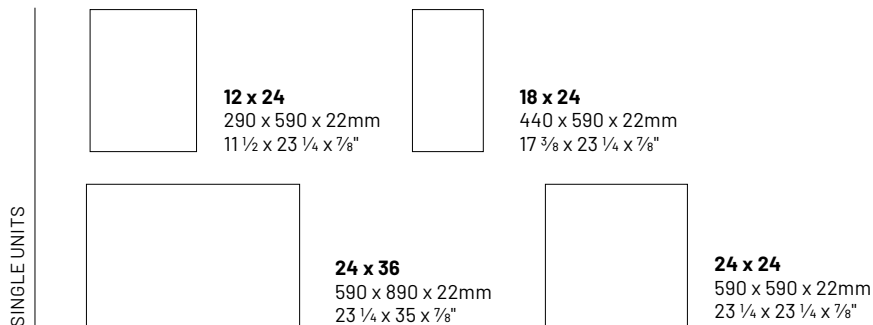
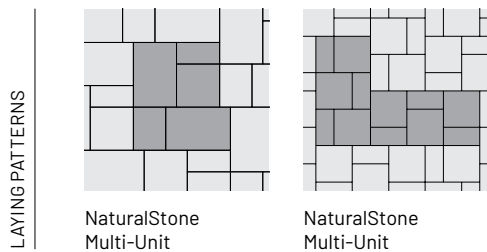

Notes: **SOLD IN FULL CRATES ONLY.** This product is not intended for vehicular applications. All measurements are nominal. Contact Unilock for more information. **STOCKED IN MARENGO.**

Natural Stone Random Bundle



APPLICATIONS

Pedestrian

APPEARANCE

Edge Detail - Sawn

Surface Texture - Natural Finish

Joint Spacing - 10 mm

TECHNICAL INFORMATION

Visit Unilock.com for more information.

LAYING PATTERNS

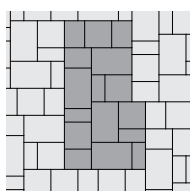

NaturalStone
Fixed RB

4 UNIT RANDOM

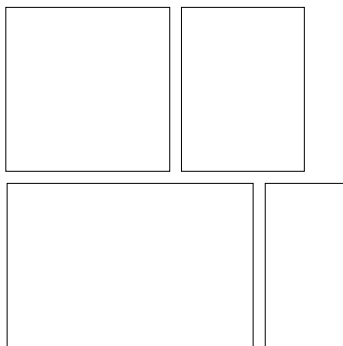

24 x 24
590 x 590 x 38mm
23 1/4 x 23 1/4 x 1 1/2"

18 x 24
440 x 590 x 38mm
17 3/8 x 23 1/4 x 1 1/2"

24 x 36
590 x 890 x 38mm
23 1/4 x 35 x 1 1/2"

12 x 24
290 x 590 x 38mm
11 1/2 x 23 1/4 x 1 1/2"

SANDSTONE		4 PC BUNDLE
Bundle Type		RANDOM
Thickness (mm)		38 mm
SQFT PER	Crate	120.00
	Units	-
UNITS PER	Crate	32.00
	SqFt	-
LBS PER	Unit	-
	Bundle	2,515
Colors	Reflectance	Stock
Stone Cliff Grey	SR .27 SRI 28	✓

LIMESTONE		4 PC BUNDLE
Bundle Type		RANDOM
Thickness (mm)		38 mm
SQFT PER	Crate	120.00
	Units	-
UNITS PER	Crate	32
	SqFt	-
LBS PER	Unit	-
	Bundle	2,315
Colors	Reflectance	Stock
Hearthstone	SR n/a SRI n/a	✓



STONE CLIFF GREY

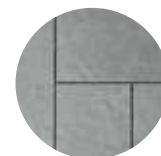

HEARTHSTONE

Notes: **SOLD IN FULL CRATES ONLY.** This project pack must be installed with a 10 mm joint space between stones. This product is not intended for vehicular applications. All measurements are nominal. Contact Unilock for more information. **STOCKED IN MARENGO.**

Natural Stone Coping



APPLICATIONS

Wall Coping, Pool Coping, Steps Treads



CASCADE



GREYFIELD

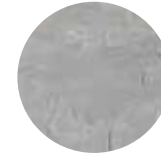

STONE CLIFF GREY



BLACK RIVER

SANDSTONE		48 x 12 STRAIGHT EDGE COPING	48 x 12 ROCKFACE COPING	48 x 14 FULLNOSE COPING	48 x 14 STRAIGHT COPING	48 x 14 ROCKFACE COPING
	Bundle Type		SINGLE	SINGLE	SINGLE	SINGLE
Thickness (mm)		50 mm	50 mm	50 mm	50 mm	50 mm

UNITS PER	Crate	20.00	20.00	20.00	20.00	16.00
	SqFt		4.00	4.00	4.67	4.67

LBS PER	Unit	97	106	117	117	113
	Crate		1,927	2,116	2,560	2,247

Colors	Reflectance	Stock	Stock	Stock	Stock	Stock
Cascade	SR n/a SRI n/a	✓	✓	✓	✓	✓
Greyfield	SR n/a SRI n/a	✓	✓	✓	✓	✓
Stone Cliff Grey	SR n/a SRI n/a	✓	✓	✓	✓	✓

LIMESTONE		48 x 12 STRAIGHT EDGE COPING	48 x 12 ROCKFACE COPING	48 x 14 FULLNOSE COPING	48 x 14 STRAIGHT COPING	48 x 14 ROCKFACE COPING
	Bundle Type		SINGLE	SINGLE	SINGLE	SINGLE
Thickness (mm)		50 mm	50 mm	50 mm	50 mm	50 mm

UNITS PER	Crate	20.00	20.00	20.00	20.00	20.00
	SqFt		4.00	4.00	4.67	4.67

LBS PER	Unit	112	112	130	130	130
	Crate		2,222	2,222	2,593	2,593

Colors	Reflectance	Stock	Stock	Stock	Stock	Stock
Black River	SR n/a SRI n/a	✓	✓	✓	✓	✓

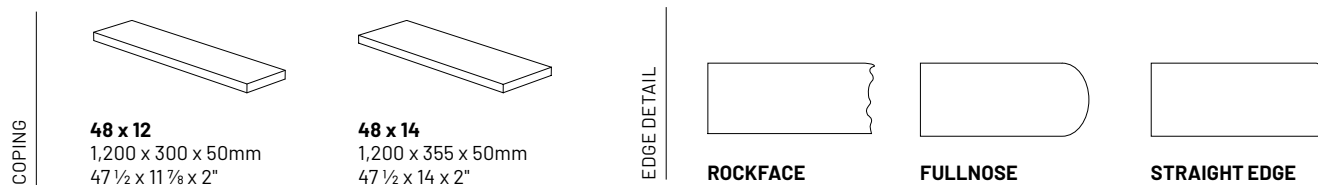

Notes: **SOLD IN FULL CRATES ONLY.** This product is not intended for vehicular applications. All measurements are nominal. Contact Unilock for more information. **STOCKED IN MARENGO ONLY**

Natural Stone Coping



APPLICATIONS

Wall Coping, Pool Coping, Steps Treads



CASCADE



GREYFIELD



STONE CLIFF GREY



BLACK RIVER

SANDSTONE		28 x 14 FULLNOSE CORNER / COPING	28 x 14 STRAIGHT CORNER / COPING	24 x 12 FULLNOSE CORNER / COPING	24 x 12 STRAIGHT CORNER / COPING	24 x 24 INSERT COPING
	Bundle Type		SINGLE	SINGLE	SINGLE	SINGLE
Thickness (mm)		50 mm	50 mm	50 mm	50 mm	50 mm

UNITS PER						
	Crate		20.00	20.00	20.00	20.00
SqFt		4.67	4.67	3.0	3.0	4.67

LBS PER						
	Unit		113	113	91	91
Crate		2,249	2,249	1,808	1,808	2,120

Colors	Reflectance	Stock	Stock	Stock	Stock	Stock
Cascade	SR n/a SRI n/a	✓	✓	✓	✓	✓
Greyfield	SR n/a SRI n/a	✓	✓	-	-	-
Stone Cliff Grey	SR n/a SRI n/a	✓	✓	-	-	-

LIMESTONE		28 x 14 FULLNOSE CORNER / COPING	28 x 14 STRAIGHT CORNER / COPING	24 x 12 FULLNOSE CORNER / COPING	24 x 12 STRAIGHT CORNER / COPING	24 x 24 INSERT COPING
	Bundle Type		SINGLE	SINGLE	SINGLE	SINGLE
Thickness (mm)		50 mm	50 mm	50 mm	50 mm	50 mm

UNITS PER						
	Crate		20.00	20.00	20.00	20.00
SqFt		4.08	4.08	3.0	3.0	4.0

LBS PER						
	Unit		117	117	84	84
Crate		2,237	2,237	1,676	1,676	1,800

Colors	Reflectance	Stock	Stock	Stock	Stock	Stock
Black River	SR n/a SRI n/a	✓	✓	-	-	-

INSERT COPING

Insert coping is ideal for those retractable pool covers. Allowing easy access while keeping a continuous look and feel.

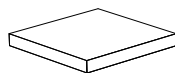

24 x 24
600 x 600 x 50mm
24 x 24 x 2"

CORNER COPING

Corner coping provides seamless 90° corners for pool, walls and so much more.

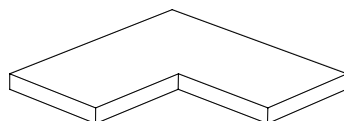

28 x 14
710 x 355 x 50mm
28 x 14 x 2"

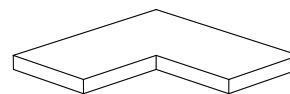

24 x 12
600 x 300 x 50mm
23 5/8 x 11 7/8 x 2"

EDGE DETAIL



STRAIGHT EDGE



FULLNOSE

Notes: SOLD IN FULL CRATES ONLY. All measurements are nominal. Contact Unilock for more information. STOCKED IN MARENGO ONLY

Natural Stone Steps & Pillar Caps



APPLICATIONS

Steps, Pillar

TECHNICAL INFORMATION

Visit Unilock.com for more information.



CASCADE

GREYFIELD

STONE CLIFF GREY

BLACK RIVER

SANDSTONE		24 x 24 PILLAR CAP	28 x 28 PILLAR CAP	48 x 16 STEP
Bundle Type		SINGLE	SINGLE	SINGLE
Thickness (mm)		64 mm	64 mm	150 mm

LNFT PER	Crate	28.00	28.00	24.00
	Unit	2.33	2.33	4.00

UNITS PER	Crate	14.00	12.00	6.00
-----------	-------	-------	-------	------

LBS PER	Unit	143	199	421
	Crate	1,991	2,385	2,526

Colors	Reflectance	Stock	Stock	Stock
Cascade	SR n/a SRI n/a	✓	✓	✓
Greyfield	SR n/a SRI n/a	✓	✓	✓
Stone Cliff Grey	SR n/a SRI n/a	✓	✓	✓

LIMESTONE		24 x 24 PILLAR CAP	28 x 28 PILLAR CAP	48 x 16 STEP
Bundle Type		SINGLE	SINGLE	SINGLE
Thickness (mm)		64 mm	64 mm	150 mm

LNFT PER	Crate	28.00	28.00	24.00
	Unit	2.33	2.33	4.00

UNITS PER	Crate	14.00	12.00	6.00
-----------	-------	-------	-------	------

LBS PER	Unit	143	207	421
	Crate	1,995	2,480	2,526

Colors	Reflectance	Stock	Stock	Stock
Black River	SR n/a SRI n/a	✓	✓	✓

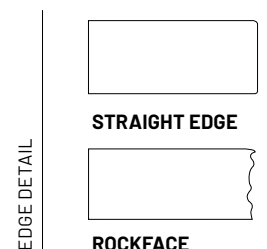
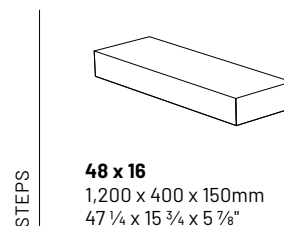
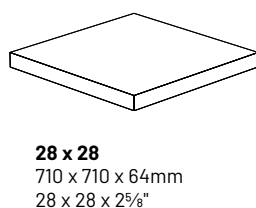
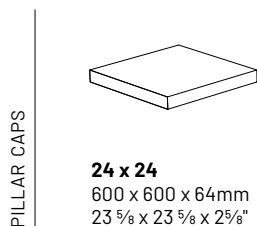

Notes: **SOLD IN FULL CRATES ONLY.** This product is not intended for vehicular applications. All measurements are nominal. Contact Unilock for more information. **STOCKED IN MARENGO**



APPLICATIONS

Pedestrian, Light Vehicular, Roadway Street,
Heavy-duty, Permeable

APPEARANCE

Edge Detail - Zero
Surface Texture - Textured
Void - 8.1%

TECHNICAL INFORMATION

Conforms to ASTM C 936
LEED Eligible
EPD's & HPD's available

Bundle Type	SINGLE
Plant Produced	CHICAGO
Thickness (mm)	60 mm

SQFT PER	Stone	0.09
	Layer	9.83
	Bundle	98.25

PER BUNDLE	Layers	10.00
------------	--------	-------

SOLDIER LNFT PER	SqFt	3.39
	Layer	33.31
	Bundle	333.07

SAILOR LNFT PER	SqFt	-
	Layer	-
	Bundle	-

UNITS PER	SqFt	10.99
	Layer	108.00
	Bundle	1,080.00

LBS PER	Unit	2
	Layer	230
	Bundle	2,301

Colors	Reflectance	Stock
Dark Charcoal	SR n/a SRI n/a	✓
Granite Fusion	SR n/a SRI n/a	✓
Opal Blend	SR n/a SRI n/a	✓

LAYER CONFIGURATION

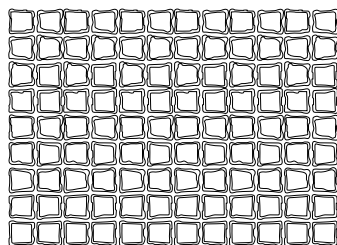

LAYING PATTERNS

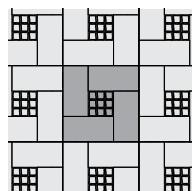

NordicCobble_A

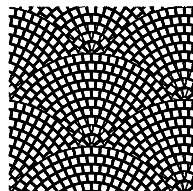

NordicCobble_Fan

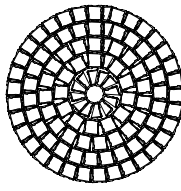

NordicCobble_Circle

SINGLE UNITS



89.9 x 94 x 60mm
3 5/8 x 3 3/4 x 2 3/8"
1,080 Units/Bundle
.09 Sq.Ft./Stone

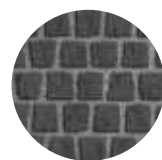

DARK CHARCOAL

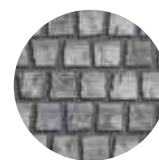

GRANITE FUSION



OPAL BLEND

Notes: **SOLD IN FULL BUNDLES ONLY** and is produced and sold on a required, refundable skid. **Important: A urethane rubber paver mat must be used to prevent scuffing when compacting on textured surfaces.** All measurements are nominal. Contact Unilock for more information. **STOCKED AT AURORA AND ELKHORN (TRANSFERABLE TO TONGANOXIE ON REQUEST)**



APPLICATIONS

Pedestrian, Light Vehicular, Roadway Street, Heavy-duty

APPEARANCE

Edge Detail - Chamfer

Surface Texture - Custom (see below)

Umbriano Mottled / Il Campo Brushed

Joint Spacing - 3 mm

TECHNICAL INFORMATION

Conforms to ASTM C 936

LEED Eligible

EPD's & HPD's available

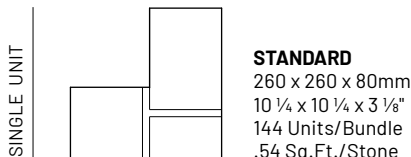
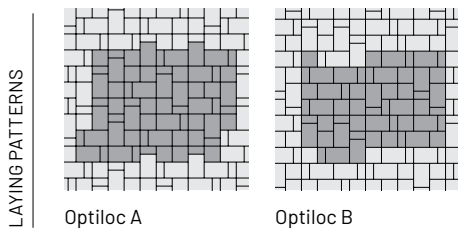
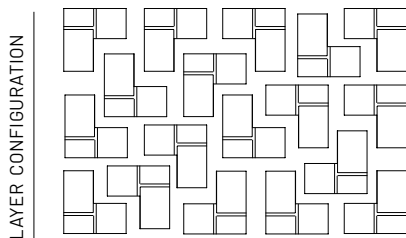

	ALL FINISHES
Bundle Type	SINGLE
Plant Produced	MULTI-PLANT
Thickness (mm)	80 mm

SQFT PER	Stone	0.54
	Layer	9.67
	Bundle	77.33

PER BUNDLE	Layers	8.00
------------	--------	------

SOLDIER LNFT PER	SqFt	1.59
	Layer	15.35
	Bundle	122.83

SAILOR LNFT PER	SqFt	1.59
	Layer	15.35
	Bundle	122.83

UNITS PER	SqFt	1.86
	Layer	18.00
	Bundle	144.00

LBS PER	Unit	19
	Layer	350
	Bundle	2,801

Colors	Reflectance	Stock
Custom Colors & Finishes	SR n/a SRI n/a	SO

Please contact your local Sales Representative for color options.

FINISH

CLASSIC Thrumix Finish IL CAMPO® Brushed Finish SERIES™ Exposed Granite Finish

SMOOTH Premier Finish UMBRIANO® Mottled Finish with/ ColorFusion and EasyClean

Notes: Special Order (SO), Lead time required. Minimum quantities apply. **SOLD IN FULL BUNDLES ONLY** and is produced and sold on a required, refundable skid. **Important: A urethane rubber paver mat must be used to prevent scuffing when compacting on textured surfaces.** All measurements are nominal. **Please note that weights are only estimated as custom finishes will alter bundle weight.** Contact Unilock for more information.



APPLICATIONS

Pedestrian, Roof Deck

APPEARANCE

Surface Texture - Stone Finish

TECHNICAL INFORMATION

Visit Unilock.com for more information.

	24 X 24 DEL CONCA PRESSED EDGE	13 X 24 DEL CONCA COPING
Bundle Type	SINGLE	SINGLE
Thickness (mm)	20 mm	30 mm

SQFT PER	Crate	248.00	-
	Box	7.75	-
	Unit	3.88	-

PER CRATE	Box	32.00	38.00
	SqFt	248.00	-
	Unit	64.00	38.00

UNITS PER	Crate	64.00	38.00
	Box	2.00	1.00

LBS PER	Unit	36	30
	SqFt	9	-
	Box	72	30
	Crate	2,288	1,127

Colors	Reflectance	Stock	Stock
Chamonix Bianco	SR n/a SRI n/a	✓	SO
Chamonix Grey	SR n/a SRI n/a	✓	SO
Gotham Grey	SR n/a SRI n/a	✓	SO
Gotham Nero	SR n/a SRI n/a	✓	SO
New England White	SR n/a SRI n/a	✓	SO
New England Ivory	SR n/a SRI n/a	✓	SO
New England Cold Grey	SR n/a SRI n/a	✓	SO
Travstone Beige	SR n/a SRI n/a	✓	SO

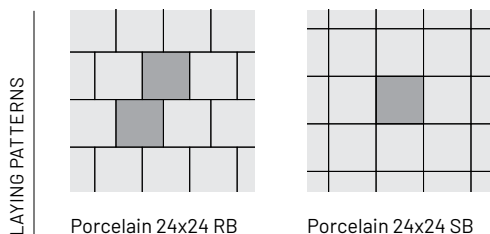

DEL CONCA SQUARE
 600 x 600 x 20mm
 23 5/8 x 23 5/8 x 7/8"
 3.88 Sq.Ft./Stone
 64 Units/Crate



DEL CONCA COPING
 330 x 600 x 30mm
 13 x 23 5/8 x 1 1/4"
 38 Units/Crate



Notes: SOLD IN FULL CRATES ONLY. Porcelain tile is available for purchase by Unilock Authorized Dealers only. All measurements are nominal. Contact Unilock for more information. Porcelain tile is not covered by Unilock's Lifetime Guarantee. Please contact your Territory Manager for more information. **Product is not intended for vehicular applications. STOCKED AT MARENGO ONLY (TRANSFERABLE TO TONGANOXIE ON REQUEST)**



APPLICATIONS

Pedestrian, Roof Deck

APPEARANCE

Surface Texture - Woodgrain Finish (DelConca) & Stone Finish

TECHNICAL INFORMATION

More information is available online.

	16 x 32 DEL CONCA PRESSED EDGE	16 x 32 UNILOCK RECTANGLE PRESSED EDGE
Bundle Type	SINGLE	SINGLE
Thickness (mm)	20 mm	20 mm

SQFT PER	Pallet	165.36	186.00
	Box	6.89	6.89
	Unit	3.45	3.44

PER PALLET	Box	24.00	27.00
	SqFt	165.36	186.00
	Unit	48.00	54.00

UNITS PER	Pallet	48.00	54.00
	Box	2.00	2.00

LBS PER	Unit	32	32
	SqFt	9	9
	Box	64	64
	Pallet	1,538	1,726

Colors	Reflectance	Stock	Stock
Cosmic Grey	SR n/a SRI n/a	-	*LSA
Dove Grey Travertine	SR n/a SRI n/a	-	*LSA
New England White	SR n/a SRI n/a	✓	-
New England Ivory	SR n/a SRI n/a	✓	-
New England Cold Gray	SR n/a SRI n/a	✓	-
Quartzite Dark Gray	SR n/a SRI n/a	✓	-
Quartzite Sand	SR n/a SRI n/a	✓	-

* Discontinued for 2026, limited stock available while supplies last

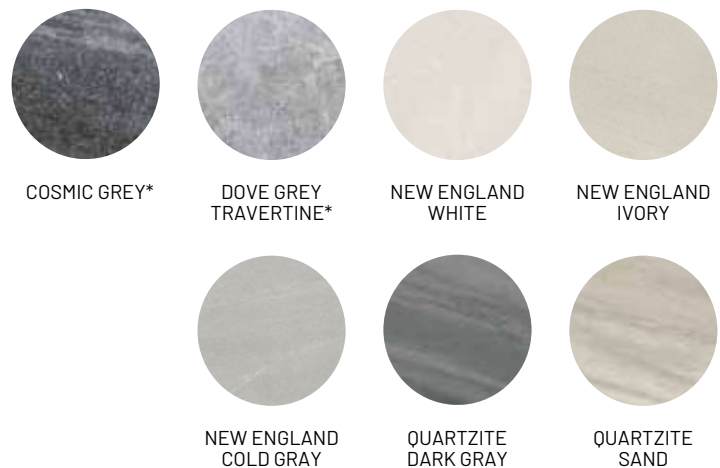
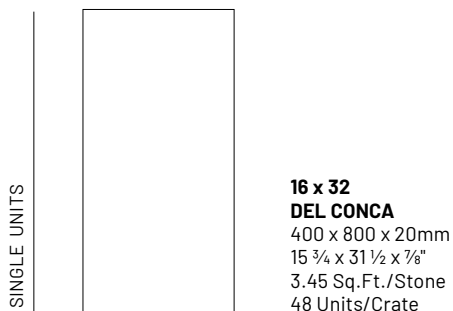
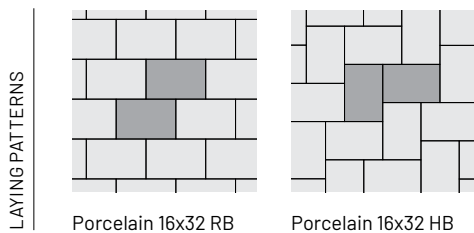

Notes: SOLD IN FULL CRATES ONLY. Porcelain tile is available for purchase by Unilock Authorized Dealers only. All measurements are nominal. Contact Unilock for more information. Porcelain tile is not covered by Unilock's Lifetime Guarantee. Please contact your Territory Manager for more information. **Product is not intended for vehicular applications. STOCKED AT MARENGO ONLY (TRANSFERABLE TO TONGANOXIE ON REQUEST)**

Porcelain Modular Bundle



APPLICATIONS

Pedestrian

APPEARANCE

Surface Texture - Stone Finish

TECHNICAL INFORMATION

More information is available online.

	DEL CONCA MODULAR BUNDLE	
	Bundle Type	RANDOM
	Thickness (mm)	20 mm

SQFT PER	Pallet	434.00
	Box	-
	Unit	-

PER PALLET	Box	-
	SqFt	-
	Unit	-

UNITS PER	Pallet	192
	Box	-

LBS PER	Unit	-
	SqFt	-
	Box	-
	Pallet	3,973

Colors	Reflectance	Stock
Travstone Beige	SR n/a SRI n/a	✓



TRAVSTONE BEIGE

LAYING PATTERNS

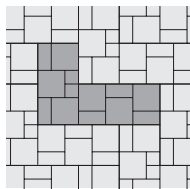

Porcelain Fixed
Random G

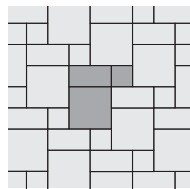

Porcelain Fixed
Random H

MODULAR BUNDLE

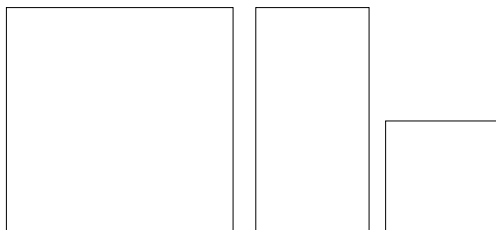

24 x 24
600 x 600 x 20mm
23 5/8 x 23 5/8 x 7/8"
64 Units/248 Sq.Ft.

12 x 24
300 x 600 x 20mm
11 7/8 x 23 5/8 x 7/8"
64 Units/124 Sq.Ft.

12 x 12
300 x 300 x 20mm
11 7/8 x 11 7/8 x 7/8"
64 Units/62 Sq.Ft.

Notes: SOLD IN FULL CRATES ONLY. All measurements are nominal. Contact Unilock for more information. Porcelain tile is not covered by Unilock's Lifetime Guarantee. Please contact your Territory Manager for more information.
Product is not intended for vehicular applications. STOCKED AT MARENGO ONLY (TRANSFERABLE TO TONGANOXIE ON REQUEST)



APPLICATIONS

Pedestrian, Light Vehicular, Roadway Street

APPEARANCE

Edge Detail - Rounded

Surface Texture - Custom (see below)

Umbriano Mottled / Il Campo Brushed

Joint Spacing - 4 mm

TECHNICAL INFORMATION

Conforms to ASTM C 936

LEED Eligible

EPD's & HPD's available

	6 x 24	6 x 24
Bundle Type	SINGLE	SINGLE
Plant Produced	MULTI-PLANT	MULTI-PLANT
Thickness (mm)	70 mm	150 mm

SQFT PER	Stone	0.97	0.97
	Layer	11.63	11.63
	Bundle	93.00	46.50

PER BUNDLE	Layers	8.00	4.00
------------	--------	------	------

SOLDIER LNFT PER	SqFt	0.51	0.51
	Layer	5.91	5.91
	Bundle	47.24	23.62

SAILOR LNFT PER	SqFt	2.03	2.03
	Layer	23.62	23.62
	Bundle	188.98	94.49

UNITS PER	SqFt	1.03	1.03
	Layer	12.00	12.00
	Bundle	96.00	48.00

LBS PER	Unit	31	67
	Layer	372	798
	Bundle	2,978	3,192

Colors	Reflectance	Stock	Stock
Custom Colors & Finishes	SR n/a SRI n/a	SO	SO
Please contact your local Sales Representative for color options.			

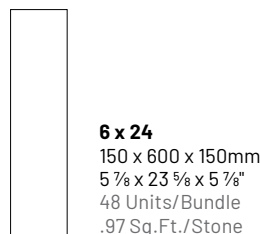
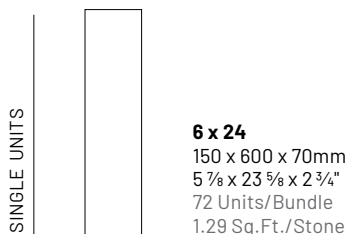
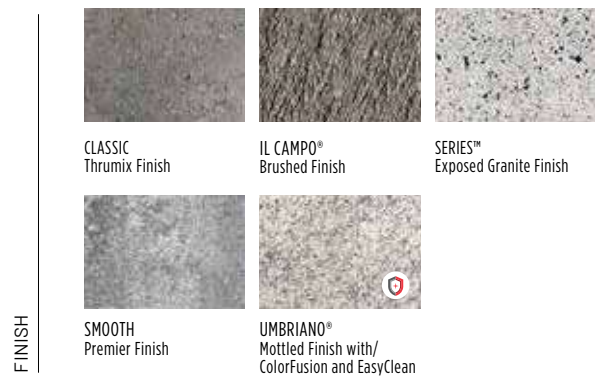
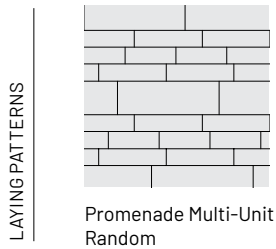

Notes: Special Order (SO), Lead time required. Minimum quantities apply. **SOLD IN FULL BUNDLES ONLY** and is produced and sold on a required, refundable skid. **Important: A urethane rubber paver mat must be used to prevent scuffing when compacting on textured surfaces.** All measurements are nominal. **Please note that weights are only estimated as custom finishes will alter bundle weight.** Contact Unilock for more information. **STOCKED AT AURORA & MARENGO**



APPLICATIONS

Pedestrian, Light Vehicular, Roadway Street,
Heavy-duty

APPEARANCE

Edge Detail - Rounded
Surface Texture - Multi-Finish Available
Joint Spacing - 4 mm

TECHNICAL INFORMATION

Conforms to ASTM C 936
LEED Eligible
EPD's & HPD's available

		3 x 12	4 x 12	4 x 16	8 x 24
	Bundle Type	SINGLE	SINGLE	SINGLE	SINGLE
	Plant Produced	MULTI-PLANT	MULTI-PLANT	MULTI-PLANT	MULTI-PLANT
	Thickness (mm)	100 mm	100 mm	100 mm	100 mm
SQFT PER	Stone	0.24	0.32	0.43	1.29
	Layer	10.66	11.63	10.33	10.33
	Bundle	63.94	58.13	51.67	51.67
PER BUNDLE	Layers	6.00	5.00	5.00	5.00
SOLDIER LNFT PER	SqFt	1.35	1.02	0.76	0.51
	Layer	14.44	11.81	7.87	5.25
	Bundle	86.61	59.06	39.37	26.25
SAILOR LNFT PER	SqFt	4.06	3.05	3.05	1.52
	Layer	43.31	35.43	31.50	15.75
	Bundle	259.84	177.17	157.48	78.74
UNITS PER	SqFt	4.13	3.10	2.32	0.77
	Layer	44.00	36.00	24.00	8.00
	Bundle	264.00	180.00	120.00	40.00
LBS PER	Unit	11	15	20	60
	Layer	465	532	469	483
	Bundle	2,789	2,659	2,345	2,414
Colors	Reflectance	Stock	Stock	Stock	Stock
Custom Colors & Finishes	SR n/a SRI n/a	SO	SO	SO	SO
Please contact your local Sales Representative for color options.					

LAYING PATTERNS

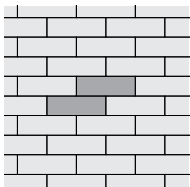

Promenade 4x12 RB

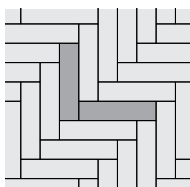

Promenade 4x16 HB

FINISH



CLASSIC
Thrumix Finish



IL CAMPO®
Brushed Finish



SERIES™
Exposed Granite Finish



SMOOTH
Premier Finish



UMBRIANO®
Mottled Finish with/
ColorFusion and EasyClean

SINGLE UNITS



3 x 12
75 x 300 x 100mm
3 x 11 7/8 x 3 7/8"
264 Units/Bundle
.24 Sq.Ft./Stone



4 x 12
100 x 300 x 100mm
3 7/8 x 11 7/8 x 3 7/8"
180 Units/Bundle
.32 Sq.Ft./Stone



4 x 16
100 x 400 x 100mm
3 7/8 x 15 3/4 x 3 7/8"
120 Units/Bundle
.43 Sq.Ft./Stone



8 x 24
200 x 600 x 100mm
7 7/8 x 23 5/8 x 3 7/8"
40 Units/Bundle
1.29 Sq.Ft./Stone

Notes: Special Order (SO), Lead time required. Minimum quantities apply. **SOLD IN FULL BUNDLES ONLY** and is produced and sold on a required, refundable skid. **Important: A urethane rubber paver mat must be used to prevent scuffing when compacting on textured surfaces.** All measurements are nominal. **Please note that weights are only estimated as custom finishes will alter bundle weight.** Contact Unilock for more information.



APPLICATIONS

Pedestrian, Light Vehicular

APPEARANCE

Edge Detail - Zero
 Surface Texture - Textured
 Joint Spacing - 10 mm

TECHNICAL INFORMATION

Conforms to ASTM C 936
 LEED Eligible
 EPD's & HPD's available

		LARGE RECTANGLE
Bundle Type	RANDOM	SINGLE
Plant Produced	AYR	AYR
Thickness (mm)	60 mm	60 mm

SQFT PER	Stone	-	1.72
	Layer	11.29	10.30
	Bundle	90.30	82.39

PER BUNDLE	Layers	8.00	8.00
------------	--------	------	------

SOLDIER LNFT PER	SqFt	-	0.58
	Layer	-	5.94
	Bundle	-	47.56

SAILOR LNFT PER	SqFt	1.31	1.01
	Layer	14.78	10.39
	Bundle	118.22	83.15

UNITS PER	SqFt	-	0.58
	Layer	20.00	6.00
	Bundle	160.00	48.00

LBS PER	Unit	-	50
	Layer	309	301
	Bundle	2,472	2,411

Colors	Reflectance	Stock	Stock
Dawn Mist	SR .37 SRI 41	✓	✓
Pebble Taupe	SR .38 SRI 42	✓	✓
Smoke Shale	SR n/a SRI n/a	✓	✓

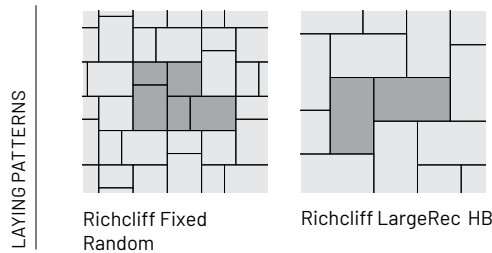
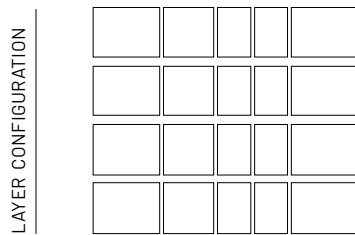

DAWN MIST



PEBBLE TAUPE

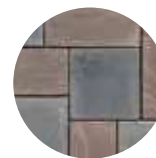

PEBBLE TAUPE
 DAWN MIST
 Blended on Site*



SMOKE SHALE

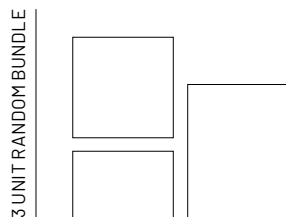

RECTANGLE
 226 x 300 x 60mm
 8 7/8 x 11 7/8 x 2 3/8"
 64 Units/Bundle
 .75 SqFt./Stone

SQUARE
 226 x 226 x 60mm
 8 7/8 x 8 7/8 x 2 3/8"
 32 Units/Bundle
 .58 Sq.Ft./Stone

SMALL RECTANGLE
 150 x 226 x 60mm
 5 7/8 x 8 7/8 x 2 3/8"
 64 Units/Bundle
 .38 Sq.Ft./Stone

SINGLE UNIT

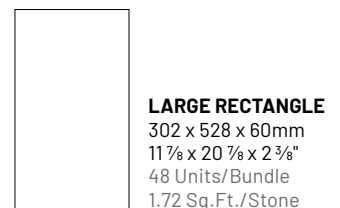

Notes: SOLD IN FULL BUNDLES ONLY and is produced and sold on a required, refundable skid. * Colors sold separately. Important: A urethane rubber paver mat must be used to prevent scuffing when compacting. All measurements are nominal. Contact Unilock for more information. STOCKED AT AURORA, ELKHORN & TONGANOXIE



APPLICATIONS

Pedestrian, Light Vehicular

APPEARANCE

Edge Detail - Chamfer

Surface Texture - Series Exposed

Joint Spacing - 3 mm

TECHNICAL INFORMATION

Conforms to ASTM C 936

LEED Eligible

EPD's & HPD's available

	4 X 8
Bundle Type	SINGLE
Plant Produced	CHICAGO
Thickness (mm)	60 mm

SQFT PER	Stone	0.22
	Layer	11.79
	Section	19.65
	Bundle	117.90

PER BUNDLE	Layers	10.00
	Sections	6.00

SOLDIER LNFT PER	SqFt	1.50
	Layer	17.72
	Section	29.53
	Bundle	177.17

SAILOR LNFT PER	SqFt	3.01
	Layer	35.43
	Section	59.06
	Bundle	354.33

UNITS PER	SqFt	4.58
	Layer	54.00
	Section	90.00
	Bundle	540.00

LBS PER	Unit	6
	Section	511
	Layer	306
	Bundle	3,065

Colors	Reflectance	Stock
Onyx Black	SR n/a SRI n/a	✓

LAYING PATTERNS

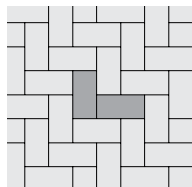

Series 4x8 HB

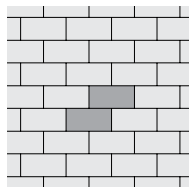

Series 4x8 RB



ONYX BLACK

SINGLE UNITS



4 x 8
 100 x 200 x 60mm
 3 7/8 x 7 7/8 x 2 3/8"
 540 Units/Bundle
 .22 Sq.Ft./Stone

Notes: Important: A urethane rubber paver mat must be used to prevent scuffing when compacting on textured surfaces. Please refer to the Sealer Best Practices on Page 93 and Important Notes on page 94. All measurements are nominal. Contact Unilock for more information. **STOCKED AT AURORA, ELKHORN & TONGANOXIE**



APPLICATIONS

Pedestrian, Roof Deck

APPEARANCE

Edge Detail - Rounded

Surface Texture - Smooth

Joint Spacing - 2 mm

TECHNICAL INFORMATION

Conforms to ASTM C 1782

LEED Eligible

EPD's & HPD's available

// Perfect for roof decks and other raised floor applications.

Ask us about our Skyview™ pedestal system.
See page 84 for more information.

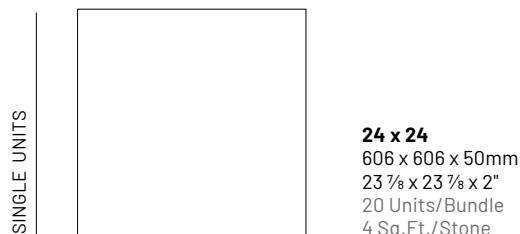
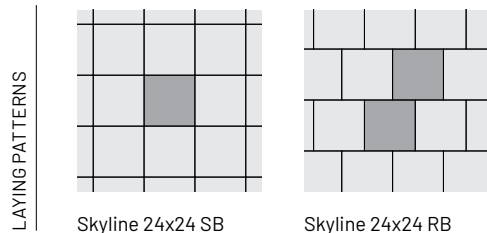

	24 x 24
Bundle Type	SINGLE
Plant Produced	MARENGO
Thickness (mm)	50 mm

SQFT PER	Stone	4.00
	Layer	8.00
	Bundle	80.00

PER BUNDLE	Layers	10.00
------------	--------	-------

SOLDIER LNFT PER	SqFt	0.50
	Layer	4.00
	Bundle	40.00

SAILOR LNFT PER	SqFt	0.50
	Layer	4.00
	Bundle	40.00

UNITS PER	SqFt	0.25
	Layer	2.00
	Bundle	20.00

LBS PER	Unit	92
	Layer	183
	Bundle	1,833

Colors	Reflectance	Stock
Chamois	SR .41 SRI 46	✓
Silver Grey	SR .34 SRI 37	✓

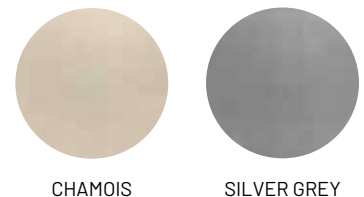

Notes: SOLD IN FULL BUNDLES ONLY and is produced and sold on a required, refundable skid. **This product is not intended for vehicular applications.** Unilock offers adjustable and stackable pedestal systems; please contact your Territory Manager for pricing and availability. All measurements are nominal. **STOCKED AT AURORA, ELKHORN & MARENGO. (TRANSFERABLE TO TONGANOXIE ON REQUEST)**



APPLICATIONS

Pedestrian, Roof Deck

APPEARANCE

Edge Detail - Micro

Surface Texture - Thermal/Flamed and Shot Blast

Joint Spacing - 0 mm

TECHNICAL INFORMATION

Conforms to ASTM C 1782

LEED Eligible

EPD's & HPD's available

// Perfect for roof decks and other raised floor applications.

Ask us about our Skyview™ pedestal system. See page 84 for more information.

	16 x 32	SHOT BLAST
Bundle Type	SINGLE	SINGLE
Plant Produced	CHICAGO	CHICAGO
Thickness (mm)	50 mm	50 mm

SQFT PER	Stone	3.57	3.57
	Layer	3.57	3.57
	Bundle	64.27	64.27

PER BUNDLE	Layers	18.00	18.00
-------------------	--------	-------	-------

SOLDIER LNFT PER	SqFt	0.37	0.38
	Layer	1.34	1.34
	Bundle	24.04	24.12

SAILOR LNFT PER	SqFt	0.75	0.75
	Layer	2.67	2.67
	Bundle	48.13	48.06

UNITS PER	SqFt	0.28	0.28
	Layer	1.00	1.00
	Bundle	18.00	18.00

LBS PER	Unit	86	86
	Layer	86	86
	Bundle	1,549	1,549

Colors	Reflectance	Stock	Stock
Dark Charcoal	SR n/a SRI n/a	-	✓
Light Granite	SR .64 SRI 50	✓	-
Toscana Beige	SR .44 SRI 77	✓	-

SLAB SPACERS



X & T Slab Spacers
Bagged & Sold Separately. See page 88 for more information.

LAYING PATTERNS

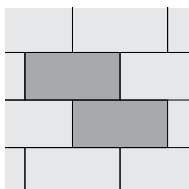

Soreno 16x32 RB

SINGLE UNITS



16 x 32
407 x 815 x 50mm
16 x 32 x 2"
18 Units/Bundle
3.57 Sq.Ft./Stone



DARK CHARCOAL

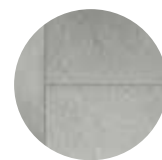

LIGHT GRANITE



TOSCANA BEIGE

Notes: SOLD IN FULL BUNDLES ONLY and is produced and sold on a required, refundable skid. **This product is not intended for vehicular applications. Important: A urethane rubber paver mat must be used to prevent scuffing when compacting.** All measurements are nominal. Unilock recommends installing Soreno using X & T Slab Spacers. Please see page 88 for more information. Contact Unilock for more information. **STOCKED AT AURORA & ELKHORN (TRANSFERABLE ON REQUEST TO TONGANOXIE)**



APPLICATIONS

Pedestrian, Light Vehicular, Roadway Street,
Border/Accents, Permeable

APPEARANCE

Edge Detail - Rounded
Surface Texture - Textured
Joint Spacing - 10 mm
Void - 6.5%

TECHNICAL INFORMATION

Conforms to ASTM C 936
LEED Eligible
EPD's & HPD's available

		STANDARD
Bundle Type		SINGLE
Plant Produced		AYR
Thickness (mm)		70 mm
SQFT PER	Stone	0.28
	Layer	11.05
	Bundle	88.41
PER BUNDLE	Layers	8.00
SOLDIER LNFT PER	SqFt	1.19
	Layer	13.12
	Bundle	104.99
SAILOR LNFT PER	SqFt	2.97
	Layer	32.81
	Bundle	262.47
UNITS PER	SqFt	3.62
	Layer	40.00
	Bundle	320.00
LBS PER	Unit	9
	Layer	361
	Bundle	2,888
Colors		Reflectance
Basalt	SR n/a SRI n/a	✓
Burgundy Red	SR .35 SRI 38	✓
Burnt Clay	SR .36 SRI 40	✓
Old Oak	SR .37 SRI 41	✓
		Stock

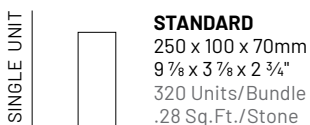
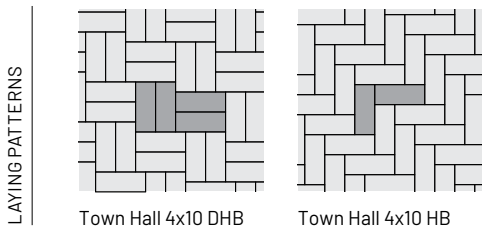

Notes: **SOLD IN FULL BUNDLES ONLY** and is produced and sold on a required, refundable skid. * Colors sold separately. **Important: A urethane rubber paver mat must be used to prevent scuffing when compacting.** All measurements are nominal. Contact Unilock for more information. **STOCKED AT AURORA & ELKHORN (TRANSFERABLE ON REQUEST TO TONGANOXIE)**



APPLICATIONS

Pedestrian, Light Vehicular, Permeable

APPEARANCE

Edge Detail - Rounded

Surface Texture - Smooth

Joint Spacing - 7 mm

Void - 5.5%

TECHNICAL INFORMATION

Conforms to ASTM C 936

LEED Eligible

EPD's & HPD's available

	SMOOTH
Bundle Type	RANDOM
Plant Produced	CHICAGO
Thickness (mm)	60 mm

SQFT PER	Stone	-
	Layer	10.90
	Bundle	108.99

PER BUNDLE	Layers	10.00
------------	--------	-------

SOLDIER LNFT PER	SqFt	-
	Layer	-
	Bundle	-

SAILOR LNFT PER	SqFt	1.35
	Layer	14.76
	Bundle	147.64

UNITS PER	SqFt	-
	Layer	21.00
	Bundle	210.00

LBS PER	Unit	-
	Layer	295
	Bundle	2,949

Colors	Reflectance	Stock
Granite	SR n/a SRI n/a	✓
River	SR .36 SRI 40	✓
Sierra	SR n/a SRI n/a	✓
Tuscany	SR n/a SRI n/a	✓

LAYER CONFIGURATION

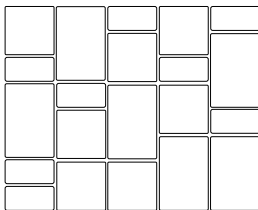

LAYING PATTERNS

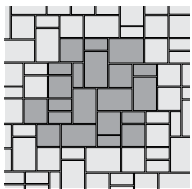

Treo Fixed Random R

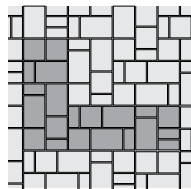

Treo Fixed Random S

RANDOM BUNDLE



LARGE RECTANGLE

225 x 337.5 x 60mm
8 7/8 x 13 3/8 x 2 3/8"
60 Units/Bundle
.82 Sq.Ft./Stone

SQUARE

225 x 225 x 60mm
8 7/8 x 8 7/8 x 2 3/8"
70 Units/Bundle
.55 Sq.Ft./Stone

SMALL RECTANGLE

112.5 x 225 x 60mm
4 1/2 x 8 7/8 x 2 3/8"
80 Units/Bundle
.27 Sq.Ft./Stone



GRANITE

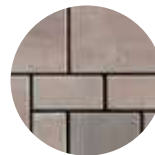

RIVER

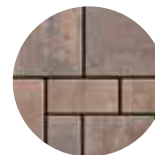

SIERRA



TUSCANY

Notes: **SOLD IN FULL BUNDLES ONLY** and is produced and sold on a required, refundable skid. **Important: A urethane rubber paver mat must be used to prevent scuffing when compacting on textured surfaces.** Please refer to the Sealer Best Practices on Page 93 and Important Notes on page 94. All measurements are nominal. Contact Unilock for more information. **STOCKED AT AURORA, ELKHORN & TONGANOXIE**



APPLICATIONS

Pedestrian, Light Vehicular, Permeable

APPEARANCE

Edge Detail - Micro

Surface Texture - Series Exposed Granite

Joint Spacing - 10 mm

Void - 5.6%

TECHNICAL INFORMATION

Conforms to ASTM C 936

LEED Eligible

EPD's & HPD's available

Bundle Type	RANDOM
Plant Produced	CHICAGO
Thickness (mm)	70 mm

SQFT PER	Stone	-
	Layer	12.19
	Bundle	97.53

PER BUNDLE	Layers	8.00
------------	--------	------

SOLDIER LNFT PER	SqFt	-
	Layer	-
	Bundle	-

SAILOR LNFT PER	SqFt	2.34
	Layer	28.49
	Bundle	227.95

UNITS PER	SqFt	-
	Layer	38.00
	Bundle	304.00

LBS PER	Unit	-
	Layer	378
	Bundle	3,022

Colors	Reflectance	Stock
Cobalt Grey	SR n/a SRI n/a	✓
Peppered Granite	SR .38 SRI 42	✓

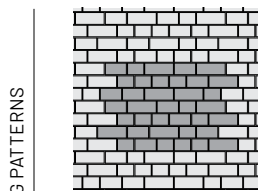
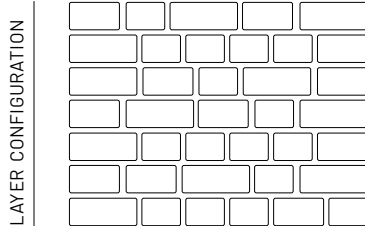

Tribeca Cobble Fixed
Random

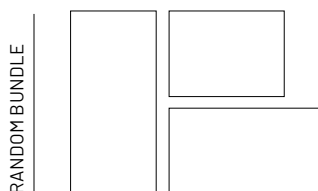

LARGE RECTANGLE
130 x 305 x 70mm
5 x 12 x 2 3/4"
88 Units/Bundle
.43 Sq.Ft./Stone

RECTANGLE
130 x 230 x 70mm
5 x 9 x 2 3/4"
88 Units/Bundle
.32 Sq.Ft./Stone

SMALL RECTANGLE
130 x 175 x 70mm
5 x 6 7/8 x 2 3/4"
128 Units/Bundle
.25 Sq.Ft./Stone



COBALT GREY



PEPPERED GRANITE

Notes: SOLD IN FULL BUNDLES ONLY and is produced and sold on a required, refundable skid. **Important:** A urethane rubber paver mat must be used to prevent scuffing when compacting on textured surfaces. For permeable installations, Unilock recommends using granite chips for joint filler. For traditional applications, please refer to the Polymeric Sand Best Practices on Page 93 and Important Notes on page 94. All measurements are nominal. Contact Unilock for more information. **STOCKED AT AURORA, ELKHORN & TONGANOXIE**



APPLICATIONS

Pedestrian, Light Vehicular, Permeable,
Roadway Street

APPEARANCE

Edge Detail - Zero
Surface Texture - Smooth
Joint Spacing - 2 mm
Void - 40%

TECHNICAL INFORMATION

Conforms to ASTM C 936
LEED Eligible
EPD's & HPD's available

Bundle Type	SINGLE
Plant Produced	CHICAGO/ ELKHORN
Thickness (mm)	80 mm

SQFT PER	Stone	2.50
	Layer	10.00
	Bundle	80.00

PER BUNDLE	Layers	8.00
------------	--------	------

SOLDIER LNFT PER	SqFt	-
	Layer	-
	Bundle	-

SAILOR LNFT PER	SqFt	-
	Layer	-
	Bundle	-

UNITS PER	SqFt	0.40
	Layer	4.00
	Bundle	32.00

LBS PER	Unit	62
	Layer	249
	Bundle	1,995

Colors	Reflectance	Stock
Natural	SR .30 SRI 32	SO

LAYER CONFIGURATION

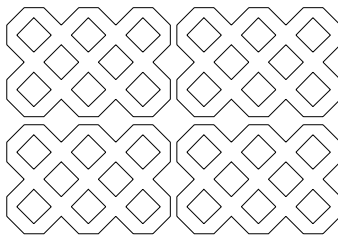

LAYING PATTERNS

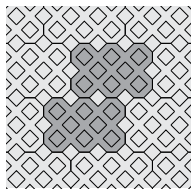

Turfstone

SINGLE UNIT

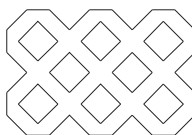

STANDARD
400 x 600 x 80mm
15 3/4 x 23 5/8 x 3 1/8"
32 Units/Bundle
2.50 Sq.Ft./Stone



NATURAL

Notes: **Special Order (SO), Lead time required.** Minimum quantities apply. **SOLD IN FULL BUNDLES ONLY** and is produced and sold on a required, refundable skid. All measurements are nominal. Contact Unilock for more information.



APPLICATIONS

Pedestrian

APPEARANCE

Edge Detail - Rounded

Surface Texture - Umbriano Mottled

Joint Spacing - 3 mm

TECHNICAL INFORMATION

Conforms to ASTM C 936

LEED Eligible

EPD's & HPD's available

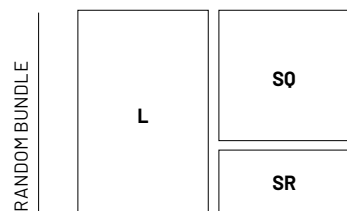
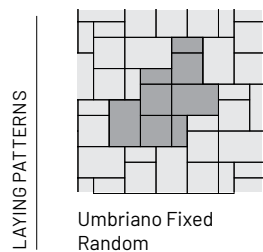
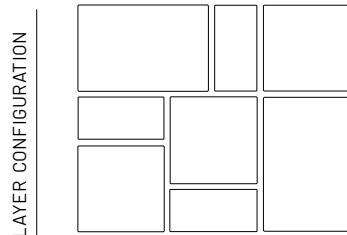

LARGE RECTANGLE
380 x 570 x 60mm
15 x 22 1/2 x 2 3/8"
20 Units/Bundle
2.331 Sq.Ft./Stone

SQUARE
380 x 380 x 60mm
15 x 15 x 2 3/8"
30 Units/Bundle
1.554 Sq.Ft./Stone

SMALL RECTANGLE
190 x 380 x 60mm
7 1/2 x 15 x 2 3/8"
30 Units/Bundle
.77 Sq.Ft./Stone

Bundle Type	RANDOM
Plant Produced	MARENGO
Thickness (mm)	60 mm

SQFT PER	Stone	-
	Layer	11.66
	Bundle	116.57

PER BUNDLE	Layers	10.00
------------	--------	-------

SOLDIER LNFT PER	SqFt	-
	Layer	-
	Bundle	-

SAILOR LNFT PER	SqFt	0.80
	Layer	9.35
	Bundle	93.50

UNITS PER	SqFt	-
	Layer	8.00
	Bundle	80.00

LBS PER	Unit	-
	Layer	320
	Bundle	3,194

Colors	Reflectance	Stock
French Grey	SR .18 SRI 17	✓
Grenada White	SR .45 SRI 52	✓
Midnight Sky	SR .17 SRI 15	✓
Summer Wheat	SR .42 SRI 48	✓
Winter Marvel	SR .35 SRI 38	✓



FRENCH GREY

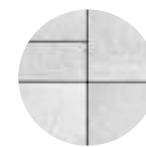

GRENADA WHITE

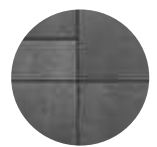

MIDNIGHT SKY



SUMMER WHEAT

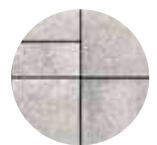

WINTER MARVEL

Notes: SOLD IN FULL BUNDLES ONLY and is produced and sold on a required, refundable skid. **Important: A urethane rubber paver mat must be used to prevent scuffing when compacting on textured surfaces.** Please refer to the Sealer Best Practices on Page 93 and Important Notes on page 94. All measurements are nominal. Contact Unilock for more information. **STOCKED AT AURORA, ELKHORN, MARENGO & TONGANOXIE**

Umbriano® 60mm Slabs



APPLICATIONS

Pedestrian

APPEARANCE

Edge Detail - Rounded

Surface Texture - Umbriano Mottled

Joint Spacing - 3 mm

TECHNICAL INFORMATION

Conforms to ASTM C 936

LEED Eligible

EPD's & HPD's available

	XL
Bundle Type	SINGLE
Plant Produced	MARENGO
Thickness (mm)	60 mm

SQFT PER	Stone	5.83
	Layer	11.66
	Bundle	116.57

PER BUNDLE	Layers	10.00
------------	--------	-------

SOLDIER LNFT PER	SqFt	0.32
	Layer	3.74
	Bundle	37.40

SAILOR LNFT PER	SqFt	0.53
	Layer	6.23
	Bundle	62.30

UNITS PER	SqFt	0.17
	Layer	2.00
	Bundle	20.00

LBS PER	Unit	160
	Layer	320
	Bundle	3,186

Colors	Reflectance	Stock
French Grey	SR .18 SRI 17	✓
Grenada White	SR .45 SRI 52	✓
Midnight Sky	SR .17 SRI 15	✓
Summer Wheat	SR .42 SRI 48	✓
Winter Marvel	SR .35 SRI 38	✓



FRENCH GREY

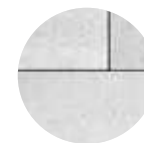

GRENADA WHITE

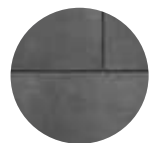

MIDNIGHT SKY

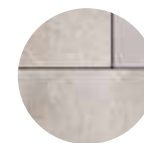

SUMMER WHEAT

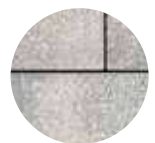

WINTER MARVEL

SINGLE UNITS

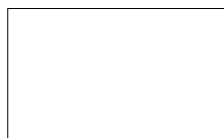

XL
570 x 950 x 60mm
22 1/2 x 37 1/2 x 2 3/8"
20 Units/Bundle
5.83 Sq.Ft./Stone

Notes: SOLD IN FULL BUNDLES ONLY and is produced and sold on a required, refundable skid. **Important: A urethane rubber paver mat must be used to prevent scuffing when compacting on textured surfaces.** Please refer to the Sealer Best Practices on Page 93 and Important Notes on page 94. All measurements are nominal. Contact Unilock for more information. **STOCKED AT AURORA, ELKHORN, MARENGO & TONGANOXIE**



		5 x 10
Bundle Type	RANDOM	SINGLE
Plant Produced	ELKHORN	ELKHORN
Thickness (mm)	70 mm	70 mm

SQFT PER	Stone	-	0.34
	Layer	11.77	11.77
	Bundle	94.19	94.19

PER BUNDLE	Layers	8.00	8.00
------------	--------	------	------

SOLDIER LNFT PER	SqFt	-	0.71
	Layer	-	8.33
	Bundle	-	66.67

SAILOR LNFT PER	SqFt	1.24	1.42
	Layer	14.57	16.67
	Bundle	116.56	133.33

UNITS PER	SqFt	-	2.97
	Layer	20.00	35.00
	Bundle	160.00	280.00

LBS PER	Unit	-	10
	Layer	372	361
	Bundle	2,976	2,884

Colors	Reflectance	Stock	Stock
Charcoal	SR n/a SRI n/a	-	✓
Granite	SR n/a SRI n/a	✓	-
River	SR n/a SRI n/a	✓	-
Sierra	SR n/a SRI n/a	✓	-

APPLICATIONS

Pedestrian, Light Vehicular, Border/Accents

APPEARANCE

Edge Detail - Zero

Surface Texture - Textured

Joint Spacing - 3 mm

TECHNICAL INFORMATION

Conforms to ASTM C 936

LEED Eligible

EPD's & HPD's available

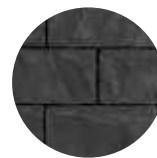
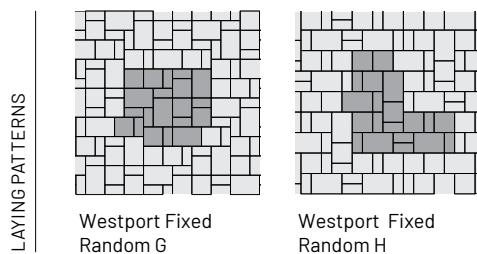
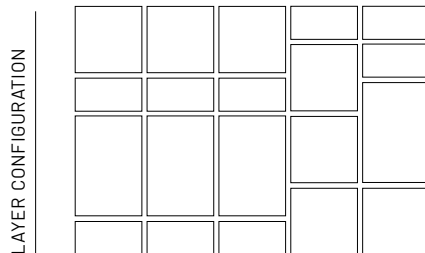

CHARCOAL

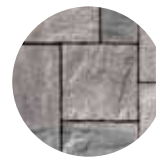

GRANITE

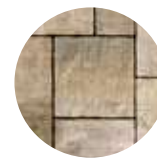

RIVER



SIERRA

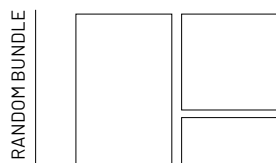

LARGE RECTANGLE
254x 380 x 70mm
10 x 15 x 2 3/4"
32 Units/Bundle
1.01 Sq.Ft./Stone

SQUARE
254 x 254 x 70mm
10 x 10 x 2 3/4"
56 Units/Bundle
.67 Sq.Ft./Stone

RECTANGLE
127x 254 x 70mm
5 x 10 x 2 3/4"
72 Units/Bundle
.34 Sq.Ft./Stone

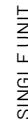

5 x 10 RECTANGLE
127x 254 x 70mm
5 x 10 x 2 3/4"
280 Units/Bundle
.34 Sq.Ft./Stone

Notes: SOLD IN FULL BUNDLES ONLY and is produced and sold on a required, refundable skid. Important: A urethane rubber paver mat must be used to prevent scuffing when compacting on textured surfaces. Please refer to the Sealer Best Practices on Page 93 and Important Notes on page 94. All measurements are nominal. Contact Unilock for more information. STOCKED AT AURORA, ELKHORN & TONGANOXIE

Factory sealed to protect surface texture and color.



		5 x 10
Bundle Type	RANDOM	SINGLE
Plant Produced	ELKHORN	ELKHORN
Thickness (mm)	70 mm	70 mm

SQFT PER	Stone	-	0.34
	Layer	11.77	11.77
	Bundle	94.19	94.19

PER BUNDLE	Layers	8.00	8.00
------------	--------	------	------

SOLDIER LNFT PER	SqFt	-	0.71
	Layer	-	8.33
	Bundle	-	66.67

SAILOR LNFT PER	SqFt	1.24	1.42
	Layer	14.57	16.67
	Bundle	116.56	133.33

UNITS PER	SqFt	-	2.97
	Layer	20.00	35.00
	Bundle	160.00	280.00

LBS PER	Unit	-	10
	Layer	366	361
	Bundle	2,928	2,884

Colors	Reflectance	Stock	Stock
Charcoal	SR n/a SRI n/a	-	✓
Granite	SR n/a SRI n/a	✓	-
River	SR n/a SRI n/a	✓	-
Sierra	SR n/a SRI n/a	✓	-

APPLICATIONS

Pedestrian, Light Vehicular, Border/Accents

APPEARANCE

Edge Detail - Zero

Surface Texture - Smooth

Joint Spacing - 3 mm

TECHNICAL INFORMATION

Conforms to ASTM C 936

LEED Eligible

EPD's & HPD's available

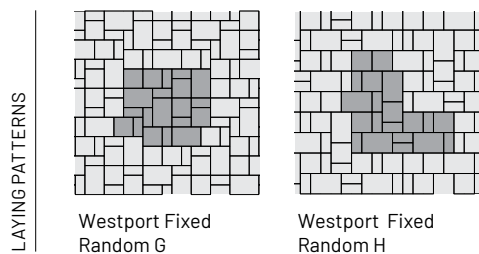
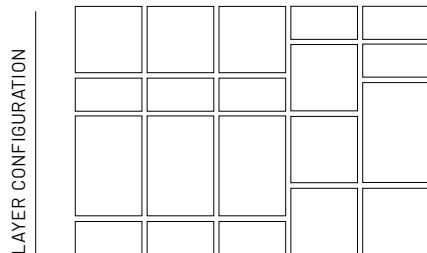

CHARCOAL



GRANITE

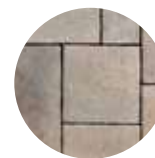

RIVER



SIERRA

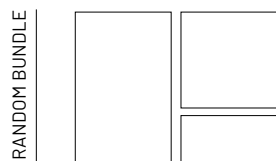

LARGE RECTANGLE
254x 380 x 70mm
10 x 15 x 2 3/4"
32 Units/Bundle
1.01 Sq.Ft./Stone

SQUARE
254 x 254 x 70mm
10 x 10 x 2 3/4"
56 Units/Bundle
.67 Sq.Ft./Stone

RECTANGLE
127x 254 x 70mm
5 x 10 x 2 3/4"
72 Units/Bundle
.34 Sq.Ft./Stone

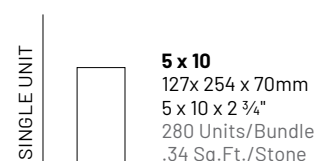

Notes: SOLD IN FULL BUNDLES ONLY and is produced and sold on a required, refundable skid. Important: A urethane rubber paver mat must be used to prevent scuffing when compacting on textured surfaces. Please refer to the Sealer Best Practices on Page 93 and Important Notes on page 94. All measurements are nominal. Contact Unilock for more information. STOCKED AT AURORA, ELKHORN & TONGANOXIE

Brussels Dimensional Stone®



APPLICATIONS

Garden Wall, Seat Wall, Steps, Outdoor Kitchen, Pillar, Fire Feature, Water Feature

APPEARANCE

Surface Texture - Weathered

CROSS SECTIONS

Cross Sections are available on Unilock's Contractor website under Products: contractor.unilock.com

TECHNICAL INFORMATION

Conforms to ASTM C 1372
LEED Eligible
EPD's & HPD's available

	TAPERED	STANDARD
Bundle Type	SINGLE	SINGLE
Plant Produced	MULTI-PLANT	MULTI-PLANT
Thickness (mm)	100 mm	100 mm

FCFT PER	Stone	0.25	0.33
	Layer	6.00	5.33
	Bundle	36.00	32.00

PER BUNDLE	Layers	6.00	6.00
	Sections	-	4.00

LNFT PER	Unit	0.75	1.00
	Bundle	108.00	96.00

UNITS PER	SqFt	4.00	3.00
	Section	-	24.00
	Layer	24.00	16.00
	Bundle	144.00	96.00

LBS PER	Units	20	31
	Section	-	736
	Layer	488	491
	Bundle	2,930	2,944

Colors	Reflectance	Stock	Stock
Granite	SR.n/a SRI n/a	✓	-
Limestone	SR.n/a SRI n/a	-	✓
Sandstone	SR.n/a SRI n/a	✓	✓
Sierra	SR.n/a SRI n/a	✓	✓



GRANITE



LIMESTONE



SANDSTONE



SIERRA

SINGLE UNITS

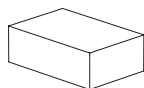

STANDARD
300 x 200 x 100mm
11 7/8 x 7 7/8 x 3 7/8"
96 Units/Bundle
.33 Fc.Ft./Stone

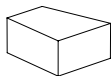

TAPERED
229 x 200 x 100mm
9 x 7 7/8 x 3 7/8"
144 Units/Bundle
.25 Fc.Ft./Stone

SUNSET FIRE PIT KIT

Located on page 82



ROUND



SQUARE

Notes: SMALL TAPERED UNITS ARE SOLD IN FULL BUNDLES ONLY. Maximum height is 24" (under optimum conditions). *Based on 12" deep wall coverage = 21.4 sqft per bundle. Based on an 8" deep wall coverage = 32 sqft per bundle. LedgeStone™, Brussels Block® XL or 6" x 12" Fullnose complement as a possible coping unit. All measurements are nominal. Contact Unilock for more information. **STOCKED AT AURORA, ELKHORN & TONGANOXIE**

Dura Hold®



APPLICATIONS

Structural Walls

APPEARANCE

Surface Texture - Smooth

CROSS SECTIONS

Cross Sections are available on Unilock's

Contractor website under Products:

contractor.unilock.com

TECHNICAL INFORMATION

Conforms to ASTM C 1372

LEED Eligible

EPD's & HPD's available

	TIE-BACK	COPING HALF	CORNER 45°
Bundle Type	SINGLE	SINGLE	SINGLE
Plant Produced	GORMLEY	GORMLEY	GORMLEY
Thickness (mm)	300 mm	300 mm	300 mm

FCFT PER	Stone	2.00	3.00	7.04
	Layer	2.00	3.00	7.04
	Bundle	2.00	3.00	7.04

PER BUNDLE	Layers	1.00	1.00	1.00
------------	--------	------	------	------

LNFT PER	Unit	-	3.00	-
	Bundle	-	3.00	-

UNITS PER	SqFt	0.50	0.33	0.14
	Layer	1.00	1.00	1.00
	Bundle	1.00	1.00	1.00

LBS PER	Units	1,660	800	1,480
	Layer	1,660	800	1,480
	Bundle	1,660	800	1,480

Colors	Reflectance	Stock	Stock	Stock
Natural	SR n/a SRI n/a	SO	SO	SO



NATURAL

SINGLE UNITS

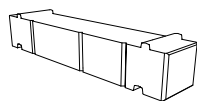

TIE-BACK
1830 x 600 x 300mm
72 x 23 5/8 x 11 7/8"
1 unit/Bundle
2.00 Fc.Ft./Stone

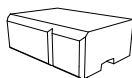

COPING HALF
915 x 600 x 300mm
36 x 23 5/8 x 11 7/8"
1 unit/Bundle
3.00 Fc.Ft./Stone

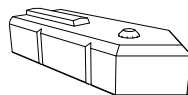

CORNER 45°
1520x 600 x 300mm
59 7/8 x 23 5/8 x 11 7/8"
1 unit/Bundle
7.04 Fc.Ft./Stone

Notes: Special Order (SO), Lead time required. Minimum quantities apply. **SOLD IN FULL BUNDLES ONLY.** Closed-end coping units are closed on both ends so that they may be used as left or right units. Tie-back units are reinforced with steel. 1/2 Standard units are slightly tapered and can be used to create a 45 foot radius. Refer to terms and conditions for placement rates. Unilock, through Risi Stone® Systems International, can provide preliminary site engineering for most commercial projects. Soils information, site drawings, and loading requirements are some of the information details required in order to provide this preliminary site engineering. All measurements are nominal. Contact Unilock for more information.

Estate Wall™



APPLICATIONS

Pillar, Steps, Outdoor Kitchen, Fire Feature, Water Feature, Structural Walls, Garden Wall, Seat Wall

APPEARANCE

Surface Texture - Split

CROSS SECTIONS

Cross Sections are available on Unilock's Contractor website under Products:

contractor.unilock.com

TECHNICAL INFORMATION

Conforms to ASTM C 1372

LEED Eligible

EPD's & HPD's available

		PILLAR / CORNER	COPING TAPERED
Bundle Type	RANDOM	SINGLE	SINGLE
Plant Produced	CHICAGO	CHICAGO	CHICAGO
Thickness (mm)	150 mm	150 mm	75 mm

FCFT PER	Stone	-	0.52	0.26
	Layer	6.25	4.17	2.34
	Bundle	31.25	20.83	18.74

PER BUNDLE	Layers	5.00	5.00	8.00
	Sections	4.00	4.00	3.00

LNFT PER	Unit	-	1.04	0.92
	Bundle	62.30	41.60	66.00

UNITS PER	SqFt	-	1.92	3.84
	Section	15.00	10.00	24.00
	Layer	12.00	8.00	9.00
	Bundle	60.00	40.00	72.00

LBS PER	Units	-	57	33
	Section	760	566	797
	Layer	608	453	299
	Bundle	3,040	2,264	2,392

Colors	Reflectance	Stock	Stock	Stock
Granite	SR.n/a SRI n/a	✓	✓	✓
River	SR.n/a SRI n/a	✓	✓	✓
Sandstone	SR.n/a SRI n/a	✓	✓	✓
Sierra	SR.n/a SRI n/a	✓	✓	✓



GRANITE



RIVER



SANDSTONE



SIERRA

RANDOM BUNDLE

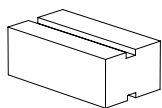

LARGE TAPERED
400 x 228 x 150mm
15 3/4 x 9 x 5 7/8"
20 Units/Bundle
.63 Fc.Ft./Stone

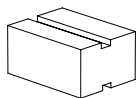

MEDIUM TAPERED
300 x 228 x 150mm
11 7/8 x 9 x 5 7/8"
20 Units/Bundle
.52 Fc.Ft./Stone

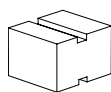

SMALL TAPERED
200 x 228 x 150mm
7 7/8 x 9 x 5 7/8"
20 Units/Bundle
.42 Fc.Ft./Stone

SINGLE UNIT

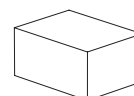

PILLAR / CORNER
320 x 230 x 150mm
12 5/8 x 9 x 5 7/8"
40 Units/Bundle
.52 Sq.Ft./Stone

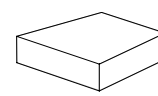

COPING TAPERED
320 x 300 x 75mm
12 5/8 x 11 7/8 x 3"
72 Units/Bundle
.26 Sq.Ft./Stone

Notes: 6" random wall bundles have convertible large units that can be used for corners or ending seat walls. End caps not sold separately. **Quarry tubing is only added to orders if requested.** LedgeStone™, Olde Quarry™ coping, Brussels Block® XL, Brussels Fullnose™ or 6" x 12" Fullnose complement as a possible coping. All measurements are nominal. Contact Unilock for more information. **STOCKED AT AURORA, ELKHORN & TONGANOXIE**

Lineo™ Dimensional Stone



APPLICATIONS

Outdoor Kitchen, Fire Feature, Water Feature, Garden Wall, Seat Wall

APPEARANCE

Surface Texture - Smooth

CROSS SECTIONS

Cross Sections are available on Unilock's Contractor website under Products:

contractor.unilock.com

TECHNICAL INFORMATION

Conforms to ASTM C 1372

LEED Eligible

EPD's & HPD's available

		PILLAR / CORNER
Bundle Type	RANDOM	SINGLE
Plant Produced	CHICAGO	CHICAGO
Thickness (mm)	100 mm	100 mm

FCFT PER	Stone	-	0.33
	Layer	10.64	9.99
	Bundle	31.91	29.97

PER BUNDLE	Layers	3.00	3.00
	Sections	-	3.00

LNFT PER	Unit	1.50	-
	Bundle	94.46	-

UNITS PER	SqFt	-	3.00
	Section	-	30.00
	Layer	21.00	30.00
	Bundle	63.00	90.00

LBS PER	Units	-	30
	Section	-	890
	Layer	948	890
	Bundle	2,845	2,670

Colors	Reflectance	Stock	Stock
Granite Blend	SR.n/a SRI n/a	✓	✓
Graphite	SR.n/a SRI n/a	✓	✓
River	SR.n/a SRI n/a	✓	✓
Sierra	SR.n/a SRI n/a	✓	✓

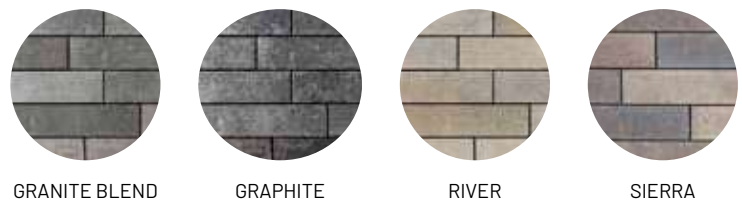

GRANITE BLEND

GRAPHITE

RIVER

SIERRA

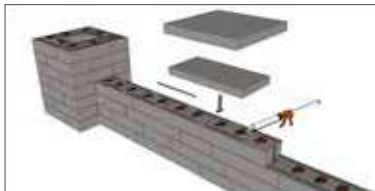
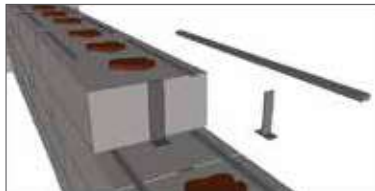

Lineo spacers are used to provide shadow effect during installation and are provided with your Lineo product.
1 Package = 144 Spacers / 68 T's

LINEO SPACERS

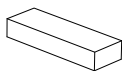

XL RECTANGLE
600 x 200 x 100mm
23 5/8 x 7 7/8 x 3 7/8"
18 Units/Bundle
.33 Fc.Ft./Stone

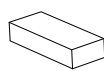

LARGE RECTANGLE
500 x 200 x 100mm
19 3/4 x 7 7/8 x 3 7/8"
15 Units/Bundle
.33 Fc.Ft./Stone



RECTANGLE
400 x 200 x 100mm
15 3/4 x 7 7/8 x 3 7/8"
15 Units/Bundle
.55 Fc.Ft./Stone



SMALL RECTANGLE
300 x 200 x 100mm
11 7/8 x 7 7/8 x 3 7/8"
15 Units/Bundle
.44 Fc.Ft./Stone



PILLAR/CORNER
300 x 200 x 100mm
11 7/8 x 7 7/8 x 3 7/8"
90 Units/Bundle
.33 Fc.Ft./Stone

RANDOM BUNDLE

SINGLE UNIT

Notes: SOLD IN FULL BUNDLES ONLY and is produced on a required, refundable skid. Lineo spacers are shipped with random wall bundles to create even spacing between units. LedgeStone™, Unilock Natural Stone or 6" x 12" Fullnose complement as possible coping options. All measurements are nominal. Contact Unilock for more information. **STOCKED AT AURORA, ELKHORN & TONGANOXIE**

Olde Quarry™



APPLICATIONS

Pillar, Steps, Outdoor Kitchen, Fire Feature, Water Feature, Garden Wall, Seat Wall

APPEARANCE

Surface Texture - Standard

CROSS SECTIONS

Cross Sections are available on Unilock's Contractor website under Products:

contractor.unilock.com

TECHNICAL INFORMATION

Conforms to ASTM C 1372

LEED Eligible

EPD's & HPD's available

	WALL	CORNER	COPING TAPERED
Bundle Type	RANDOM	SINGLE	SINGLE
Plant Produced	WISCONSIN	CHICAGO	CHICAGO
Thickness (mm)	114 mm	114 mm	75 mm

FCFT PER	Stone	-	0.39	0.25
	Layer	5.63	6.18	3.00
	Bundle	33.75	30.89	24.00

PER BUNDLE	Layers	6.00	5.00	8.00
	Sections	5.00	4.00	4.00

LNFT PER	Unit	-	1.03	1.00
	Bundle	90.00	82.40	96.00

UNITS PER	SqFt	-	2.59	4.00
	Section	18.00	20.00	24.00
	Layer	15.00	16.00	12.00
	Bundle	90.00	80.00	96.00

LBS PER	Units	-	39	32
	Section	625	788	760
	Layer	521	630	380
	Bundle	3,125	3,150	3,039

Colors	Reflectance	Stock	Stock	Stock
Granite	SR.n/a SRI n/a	✓	✓	✓
River	SR.n/a SRI n/a	✓	✓	✓
Sandstone	SR.n/a SRI n/a	✓	✓	✓
Sierra	SR.n/a SRI n/a	✓	✓	✓



GRANITE



RIVER



SANDSTONE



SIERRA

RANDOM BUNDLE

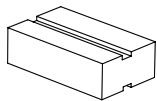

15" LARGE TAPERED
380 x 230 x 114mm
15 x 9 x 4 1/2"
30 Units/Bundle
.47 Fc.Ft./Stone

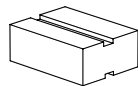

12" MEDIUM TAPERED
305 x 230 x 114mm
11 7/8 x 9 x 4 1/2"
30 Units/Bundle
.38 Fc.Ft./Stone

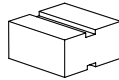

9" SMALL TAPERED
230 x 230 x 114mm
9 x 9 x 4 1/2"
30 Units/Bundle
.28 Fc.Ft./Stone

SINGLE UNITS

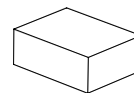

CORNER
300 x 230 x 114mm
11 7/8 x 9 x 4 1/2"
80 Units/Bundle
.39 Fc.Ft./Stone



COPING TAPERED
305 x 305 x 75mm
12 x 12 x 3"
96 Units/Bundle
.25 Fc.Ft./Stone

Notes: Structural retaining walls greater than 2' high require professional engineering. Quarry Coping sold and produced on a returnable, refundable pallet. **Quarry tubing is added to orders when requested. Tubing may be used to set back walls.** LedgeStone™, Olde Quarry™ Coping, Brussels Block™ XL, Brussels Fullnose™ or 6" x 12" Fullnose complement as a possible coping. All measurements are nominal. Contact Unilock for more information. **STOCKED AT AURORA, ELKHORN & TONGANOXIE**

Pisa™ & Pisa XL



APPLICATIONS

Pillar, Steps, Structural Walls, Garden Wall, Seat Wall

APPEARANCE

Surface Texture - Split

CROSS SECTIONS

Cross Sections are available on Unilock's Contractor website under Products:

contractor.unilock.com

TECHNICAL INFORMATION

Conforms to ASTM C 1372

LEED Eligible

EPD's & HPD's available

	CORNER	XL UNIT	COPING
Bundle Type	DOUBLE	SINGLE	DOUBLE
Plant Produced	CHICAGO	CHICAGO	CHICAGO
Thickness (mm)	150 mm	150 mm	75 mm

FCFT PER	Stone	1.67	0.67	0.50
	Layer	10.00	5.33	3.00
	Bundle	30.01	26.66	21.00

PER BUNDLE	Layers	3.00	5.00	7.00
	Sections	6.00	-	2.00

LNFT PER	Unit	-	1.33	2.00
	Bundle	-	53.34	84.00

UNITS PER	SqFt	0.60	1.50	2.00
	Section	3.00	-	21.00
	Layer	6.00	8.00	6.00
	Bundle	18.00	40.00	42.00

LBS PER	Units	91	77	68
	Section	274	-	1,437
	Layer	547	618	411
	Bundle	1,641	3,091	2,875

Colors	Reflectance	Stock	Stock	Stock
Granite	SR.n/a SRI n/a	✓	✓	✓
Nevada	SR.n/a SRI n/a	✓	✓	✓
Sierra	SR.n/a SRI n/a	✓	✓	✓



GRANITE



NEVADA



SIERRA

SINGLE OR DOUBLE UNITS BUNDLE

CORNER
 200 x 300 x 150mm
 7 7/8 x 11 7/8 x 5 7/8"
 18 Double Units/Bundle
 36 Single Units/Bundle
 1.67 Fc.Ft./Double Unit

COPING
 300 x 300 x 75mm
 11 7/8 x 11 7/8 x 3"
 42 Double Units/Bundle
 .48 Fc.Ft./Stone

SINGLE UNIT

XL TAPERED UNIT
 400 x 300 x 150mm
 15 3/4 x 11 7/8 x 5 7/8"
 40 Single Units/Bundle
 .67 Fc.Ft./Stone

Notes: XL UNITS ARE SOLD IN FULL BUNDLES ONLY. Corner and XL Units are produced and sold on a required, refundable skid. Maximum height - 36" (under optimum conditions). Higher walls can be achieved using geogrid reinforcement. The set back on Pisa wall is 3/4" every course or 1 1/2" every 2 courses. Retaining wall engineering software is also available free of charge at www.unilock.com. Walls greater than 4' in height require professional engineering. Coping bundles are Double units, packaged with 16 closed end pieces per bundle. (8 Left & 8 Right). 12" Closed End Coping pieces are not sold separately. All measurements are nominal. Contact Unilock for more information. **STOCKED AT AURORA, ELKHORN & TONGANOXIE**

Pisa™ XL Smooth



APPLICATIONS

Pillar, Steps, Garden Wall, Seat Wall

APPEARANCE

Surface Texture - Smooth

CROSS SECTIONS

Cross Sections are available on Unilock's Contractor website under Products: contractor.unilock.com

TECHNICAL INFORMATION

Conforms to ASTM C 1372
LEED Eligible
EPD's & HPD's available

	XL CORNER	XL TAPERED	CLOSED-END / COPING
Bundle Type	SINGLE	SINGLE	BUNDLE
Plant Produced	CHICAGO	CHICAGO	CHICAGO
Thickness (mm)	150 mm	150 mm	75 mm

FCFT PER	Stone	0.97	0.65	0.32
	Layer	11.63	5.17	1.94
	Bundle	58.15	25.84	15.50

PER BUNDLE	Layers	5.00	5.00	8.00
	Sections	-	-	3.00

LNFT PER	Unit	-	-	1.31
	Bundle	-	-	62.99

UNITS PER	SqFt	1.03	1.55	3.10
	Section	-	-	16.00
	Layer	12.00	8.00	6.00
	Bundle	60.00	40.00	48.00

LBS PER	Units	60	78	48
	Section	-	-	761
	Layer	719	627	285
	Bundle	3,593	3,135	2,282

Colors	Reflectance	Stock	Stock	Stock
Alabaster	SR n/a SRI n/a	✓	✓	✓
Granite	SR n/a SRI n/a	✓	✓	✓
Fieldstone	SR n/a SRI n/a	✓	✓	✓
Charcoal	SR n/a SRI n/a	✓	✓	✓
Sandstone	SR n/a SRI n/a	-	-	✓
Natural Grey	SR n/a SRI n/a	-	-	✓

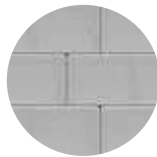

ALABASTER



CHARCOAL

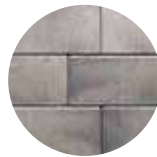

FIELDSTONE

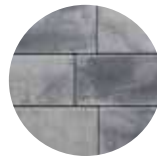

GRANITE



NATURAL GREY



SANDSTONE

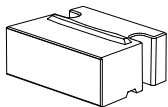

XL TAPERED
400 x 300 x 150mm
15 3/4 x 11 7/8 x 5 7/8"
40 Units/Bundle
0.65 Fc.Ft./Stone

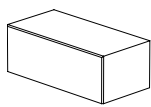

CORNER
400 x 200 x 150mm
15 3/4 x 7 7/8 x 5 7/8"
60 Units/Bundle
0.97 Fc.Ft./Stone

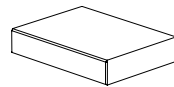

CLOSED-END
400 x 325 x 75mm
15 3/4 x 11 7/8 x 3"
24 Units/Bundle
0.32 Fc.Ft./Stone

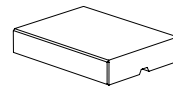

COPING
400 x 325 x 75mm
15 3/4 x 11 7/8 x 3"
24 Units/Bundle
0.32 Fc.Ft./Stone

SINGLE UNITS

DOUBLE UNIT BUNDLE

Notes: XL Corner and tapered units are **SOLD IN FULL BUNDLES ONLY** and produced on a required, refundable skid. Coping units can be used to construct steps. Retaining wall engineering software is also available free of charge at www.unilock.com. All measurements are nominal. Contact Unilock for more information. **STOCKED AT AURORA & ELKHORN (TRANSFERABLE ON REQUEST TO TONGANOXIE)**

Quarry™ Smooth



APPLICATIONS

Pillar, Outdoor Kitchen, Water Feature, Garden Wall, Seat Wall

APPEARANCE

Surface Texture - Smooth

CROSS SECTIONS

Cross Sections are available on Unilock's Contractor website under Products: contractor.unilock.com

TECHNICAL INFORMATION

Conforms to ASTM C 1372
LEED Eligible
EPD's & HPD's available

	WALL	CORNER
Bundle Type	RANDOM	SINGLE
Plant Produced	WISCONSIN	WISCONSIN
Thickness (mm)	114 mm	114 mm

FCFT PER	Stone	-	0.38
	Layer	5.63	6.08
	Bundle	33.75	18.24

PER BUNDLE	Layers	6.00	3.00
------------	--------	------	------

LNFT PER	Unit	-	-
	Bundle	-	-

UNITS PER	SqFt	-	2.63
	Layer	15.00	16.00
	Bundle	90.00	48.00

LBS PER	Units	-	40
	Layer	498	641
	Bundle	2,988	1,922

Colors	Reflectance	Stock	Stock
Charcoal	SR.n/a SRI n/a	✓	✓
Natural Grey	SR.n/a SRI n/a	✓	✓
Sandstone	SR.n/a SRI n/a	✓	✓



CHARCOAL



NATURAL GREY



SANDSTONE

RANDOM BUNDLE

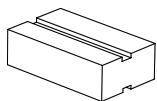

15" LARGE TAPERED
380 x 230 x 114mm
15 x 9 x 4 1/2"
30 Units/Bundle
.33 Fc.Ft./Stone

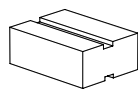

12" MEDIUM TAPERED
305 x 230 x 114mm
12 x 9 x 4 1/2"
30 Units/Bundle
.33 Fc.Ft./Stone

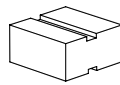

9" SMALL TAPERED
230 x 230 x 114mm
9 x 9 x 4 1/2"
30 Units/Bundle
.55 Fc.Ft./Stone

SINGLE UNITS

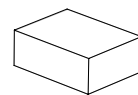

CORNER
306.6 x 228.6 x 114mm
12 x 9 x 4 1/2"
48 Units/Bundle
.38 Fc.Ft./Stone

Notes: SOLD IN FULL BUNDLES ONLY. Corner and wall bundles are produced and sold on a required, refundable skid. Structural retaining walls greater than 2' high require professional engineering. Connector units provided with every bundle upon request. Use plastic connectors on set-back walls. Quarry tubing is added to orders when requested. Tubing may be used to set back walls. LedgeStone™, Olde Quarry™ Coping, Brussels Block™ XL, Brussels Fullnose™ or 6" x 12" Fullnose complement as a possible coping. All measurements are nominal. Contact Unilock for more information. **STOCKED AT AURORA, ELKHORN & TONGANOXIE**



	WALL	CORNER	JUMPER	JUMPER CORNER
Bundle Type	RANDOM	RANDOM	RANDOM	SINGLE
Plant Produced	AYR	AYR	AYR	AYR
Thickness (mm)	57 mm	57 mm	114 mm	114 mm

FCFT PER	Stone	-	-	-	0.85
	Layer	3.04	4.05	3.43	6.77
	Bundle	24.30	16.21	13.73	13.55

PER BUNDLE	Layers	8.00	4.00	4.00	2.00
------------	--------	------	------	------	------

LNFT PER	Unit	-	-	-	0.41
	Bundle	130.69	-	-	6.56

UNITS PER	SqFt	-	-	-	1.18
	Layer	16.00	10.00	10.00	8.00
	Bundle	128.00	40.00	40.00	16.00

LBS PER	Units	-	-	-	61
	Layer	249	293	408	486
	Bundle	1,990	1,173	1,631	973

Colors	Reflectance	Stock	Stock	Stock	Stock
Buff	SR n/a SRI n/a	✓	✓	✓	✓
Coastal Slate	SR n/a SRI n/a	✓	✓	✓	✓

APPLICATIONS

Pillar, Outdoor Kitchen, Water Feature, Steps, Fire Feature, Seat Wall, Garden Wall

APPEARANCE

Surface Texture - Textured

TECHNICAL INFORMATION

Conforms to ASTM C 1372

LEED Eligible

EPD's & HPD's available

CORNER BUNDLE

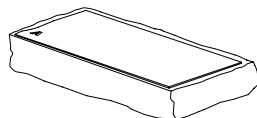

LONG CORNER UNIT
450 x 230-250 x 57mm
17 1/2 x 9-10 x 2 1/4"
20 Units/Bundle



SHORT CORNER UNIT
375 x 230-250 x 57mm
14 1/2 x 9-10 x 2 1/4"
20 Units/Bundle



BUFF



COASTAL SLATE

JUMPER RANDOM BUNDLE



JUMPER UNIT 1
200 x 230-250 x 114mm
8 x 9-10 x 4 1/2"
16 Units/Bundle



JUMPER UNIT 2 & 3
300 x 230-250 x 114mm
12 x 9-10 x 4 1/2"
12 Units/Bundle



JUMPER UNIT 4
425 x 230-250 x 114mm
17 x 9-10 x 4 1/2"
12 Units/Bundle

JUMPER CORNER UNIT

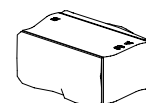

JUMPER CORNER
450 x 230-250 x 114mm
12 x 9-10 x 4 1/2"
16 Units/Bundle

UNITS RANDOM BUNDLE



STANDARD UNIT 1
200 x 230-250 x 57mm
8 x 9-10 x 2 1/4"
32 Units/Bundle

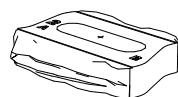

STANDARD UNIT 2
300 x 230-250 x 57mm
12 x 9-10 x 2 1/4"
32 Units/Bundle



STANDARD UNIT 3
300 x 230-250 x 57mm
12 x 9-10 x 2 1/4"
32 Units/Bundle

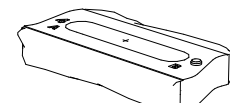

STANDARD UNIT 4
425 x 230-250 x 57mm
17 x 9-10 x 2 1/4"
32 Units/Bundle

Notes: SOLD IN FULL BUNDLES ONLY and produced on a required, refundable skid. All measurements are nominal. Contact Unilock for more information. STOCKED AT AURORA, ELKHORN & TONGANOXIE



APPLICATIONS

Pillar, Water Feature, Fire Feature,
Seat Wall, Garden Wall

APPEARANCE

Surface Texture - Textured

TECHNICAL INFORMATION

Conforms to ASTM C 1372
LEED Eligible
EPD's & HPD's available

		PILLAR UNIT	FIRE PIT RADIUS WALL
Bundle Type		SINGLE	SINGLE
Plant Produced		AYR	AYR
Thickness (mm)		114 mm	114 mm
FCFT PER	Stone	-	-
	Layer	-	-
	Bundle	-	-
PER BUNDLE	Layers	4.00	4.00
LNFT PER	Unit	-	-
	Bundle	-	-
UNITS PER	SqFt	-	-
	Layer	2.00	3.00
	Bundle	8.00	12.00
LBS PER	Units	220	117
	Layer	441	351
	Bundle	1,764	1,402
Colors		Reflectance	Stock
Buff	SR n/a SRI n/a	✓	✓
Coastal Slate	SR n/a SRI n/a	✓	✓



BUFF



COASTAL SLATE

PILLAR UNIT

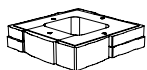

500 x 500 x 114mm
19 3/4 x 19 3/4 x 4 1/2"
Center opening 9 x 9"

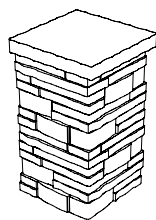

Completed Unit Shown
Pillar cap Sold Separately

FIRE PIT RADIUS WALL UNIT

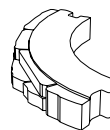

1,060 x 225 x 114mm
41 3/4 x 8 7/8 x 4 1/2"
12 units/Bundle

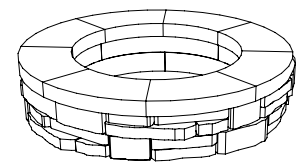

12 Wall and 1 Round ring insert
Sold Separately.

Ledgestone Fire Pit Coping
Sold Separately. See page 78

Notes: All measurements are nominal. Contact Unilock for more information.



APPLICATIONS

Seat Wall, Garden Wall, Structural Wall, Steps

APPEARANCE

Surface Texture - Smooth

CROSS SECTIONS

Cross Sections are available on Unilock's Contractor website under Products: contractor.unilock.com

TECHNICAL INFORMATION

Conforms to ASTM C 1372
LEED Eligible
EPD's & HPD's available

	STANDARD	COPING
Bundle Type	SINGLE	SINGLE
Plant Produced	CHICAGO	CHICAGO
Thickness (mm)	180 mm	180 mm

FCFT PER	Stone	1.74	1.74
	Layer	6.96	6.96
	Bundle	20.88	20.88

PER BUNDLE	Layers	3.00	3.00
------------	--------	------	------

LNFT PER	Unit	-	2.95
	Bundle	-	35.43

UNITS PER	SqFt	0.57	0.57
	Layer	4.00	4.00
	Bundle	12.00	12.00

LBS PER	Units	225	225
	Layer	898	901
	Bundle	2,695	2,702

Colors	Reflectance	Stock	Stock
Alabaster	SR n/a SRI n/a	✓	✓
Fieldstone	SR n/a SRI n/a	✓	✓
Granite	SR n/a SRI n/a	✓	✓
Charcoal	SR n/a SRI n/a	✓	✓

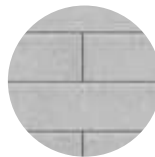

ALABASTER

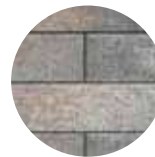

FIELDSTONE

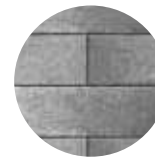

GRANITE



CHARCOAL

SINGLE UNITS

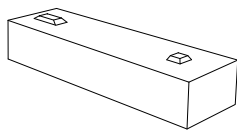

STANDARD

900 x 290 x 180mm
35 1/2 x 11 1/2 x 7"
12 Units/Bundle
1.94 Fc.Ft./Stone

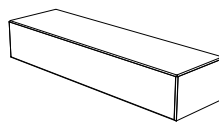

COPING

900 x 290 x 180mm
35 1/2 x 11 1/2 x 7"
12 Units/Bundle
1.94 Fc.Ft./Stone

Notes: SOLD IN FULL BUNDLES ONLY and is produced and sold on a required, refundable skid. Coping units can be used to construct steps. Retaining wall engineering software is also available free of charge at www.unilock.com. All measurements are nominal. Contact Unilock for more information. **STOCKED AT AURORA, ELKHORN & TONGANOXIE**



APPLICATIONS

Structural Wall, Garden Wall, Steps

APPEARANCE

Surface Texture - Split

CROSS SECTIONS

Cross Sections are available on Unilock's Contractor website under Products:

contractor.unilock.com

TECHNICAL INFORMATION

Conforms to ASTM C 1372

LEED Eligible

EPD's & HPD's available

	CORNER 90°	CORNER 45°	500 SPLIT	925 SPLIT	COPING
Bundle Type	SINGLE	SINGLE	SINGLE	SINGLE	SINGLE
Plant Produced	CHICAGO	CHICAGO	CHICAGO	CHICAGO	CHICAGO
Thickness (mm)	185 mm	185 mm	185 mm	185 mm	185 mm

FCFT PER	Stone	2.87	2.25	2.00	2.00	2.00
	Layer	5.73	4.50	4.00	2.00	4.00
	Bundle	17.19	13.50	12.00	6.00	12.00

PER BUNDLE	Layers	3.00	3.00	3.00	3.00	3.00
	Sections	-	-	-	-	6.00

LNFT PER	Unit	-	-	3.25	3.25	3.25
	Bundle	-	-	19.50	9.75	19.50

UNITS PER	SqFt	0.35	0.44	0.50	0.50	0.50
	Section	-	-	-	-	1.00
	Layer	2.00	2.00	2.00	1.00	2.00
	Bundle	6.00	6.00	6.00	3.00	6.00

LBS PER	Units	477	395	463	872	459
	Section	-	-	-	-	459
	Layer	954	790	926	872	919
	Bundle	2,862	2,370	2,778	2,617	2,756

Colors	Reflectance	Stock	Stock	Stock	Stock	Stock
Granite	SR n/a SRI n/a	SO	SO	SO	SO	✓
Natural	SR n/a SRI n/a	SO	SO	SO	SO	SO
Nevada	SR n/a SRI n/a	SO	SO	SO	SO	✓
Sierra	SR n/a SRI n/a	SO	SO	SO	SO	✓



GRANITE



NATURAL



NEVADA



SIERRA

SINGLE UNITS

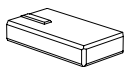

CORNER 90°

925 x 500 x 185mm
36 1/2 x 19 3/4 x 7 3/8"
6 Units/Bundle
2.87 Fc.Ft./Stone



CORNER 45°

925 x 500 x 185mm
36 1/2 x 19 3/4 x 7 3/8"
6 Units/Bundle
2.25 Fc.Ft./Stone

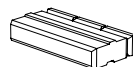

STANDARD 500 SPLIT

1000 x 500 x 185mm
39 3/8 x 19 3/4 x 7 3/8"
6 Units/Bundle
2.00 Fc.Ft./Stone

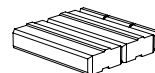

STANDARD 925 SPLIT

1000 x 925 x 185mm
39 3/8 x 36 1/2 x 7 3/8"
3 Units/Bundle
2.00 Fc.Ft./Stone

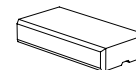

COPING

1000 x 500 x 185mm
39 3/8 x 19 3/4 x 7 3/8"
6 Units/Bundle
2.00 Fc.Ft./Stone

Notes: Special Order (SO), Lead time required. Minimum quantities apply. **SOLD IN FULL BUNDLES ONLY** and is sold on a required, refundable skid. Coping units can be sold individually to construct steps. Retaining wall engineering software is also available free of charge at www.unilock.com. All measurements are nominal. Contact Unilock for more information. **WALL & CORNERS SPECIAL ORDER PRODUCT - NON-STOCK . COPING STOCKED AT AURORA & ELKHORN**

SienaStone™ Smooth



APPLICATIONS

Steps

APPEARANCE

Surface Texture - Standard

CROSS SECTIONS

Cross Sections are available on Unilock's

Contractor website under Products:

contractor.unilock.com

TECHNICAL INFORMATION

Conforms to ASTM C 1372

LEED Eligible

EPD's & HPD's available

	48" STEP
Bundle Type	SINGLE
Plant Produced	GORMLEY
Thickness (mm)	180 mm

FCFT PER	Stone	2.33
	Layer	4.65
	Bundle	13.95

PER BUNDLE	Layers	3.00
------------	--------	------

LNFT PER	Unit	4.00
	Bundle	24.00

UNITS PER	SqFt	0.43
	Layer	2.00
	Bundle	6.00

LBS PER	Units	540
	Layer	1,081
	Bundle	3,242

Colors	Reflectance	Stock
Dusk	SR.n/a SRI n/a	✓



DUSK

SINGLE UNIS

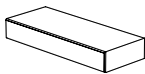

48" STEP

1200 x 500 x 180mm

47 ¼ x 19 ¾ x 7"

6 Units/Bundle

2.33 Fc.Ft./Stone

Notes: **SOLD IN FULL BUNDLES ONLY** and is sold on a required, refundable skid. All measurements are nominal. Contact Unilock for more information. **STOCKED AT AURORA, ELKHORN & TONGANOXIE**

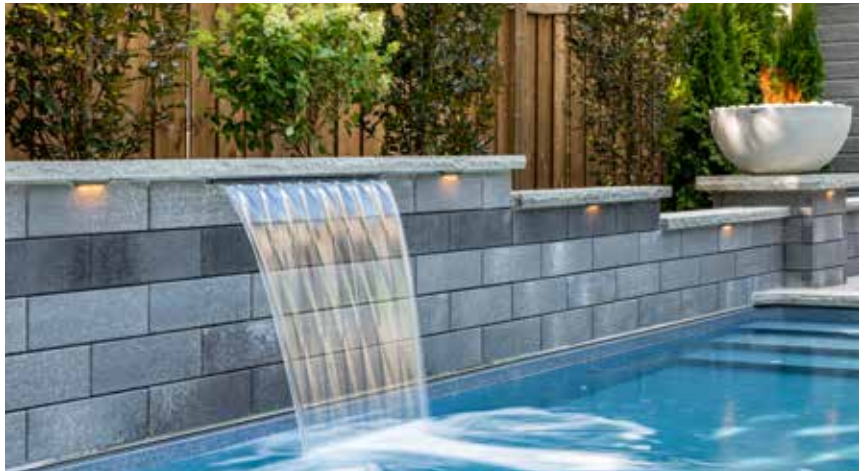

FASCIA PANELS
FINISHES



SMOOTH



PITCHED



UMBRIANO



SUBWAY

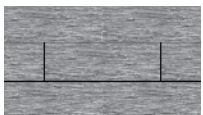

LAVANO



1/2 Running Bond

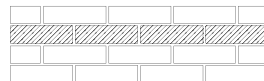

1/2 Running Bond with Linear Accents



1/2 Running Bond with Random Accents

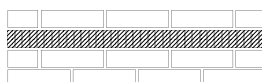

1/2 Running Bond with Paver Accents

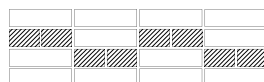

Mixed Bond







1/3 Running Bond

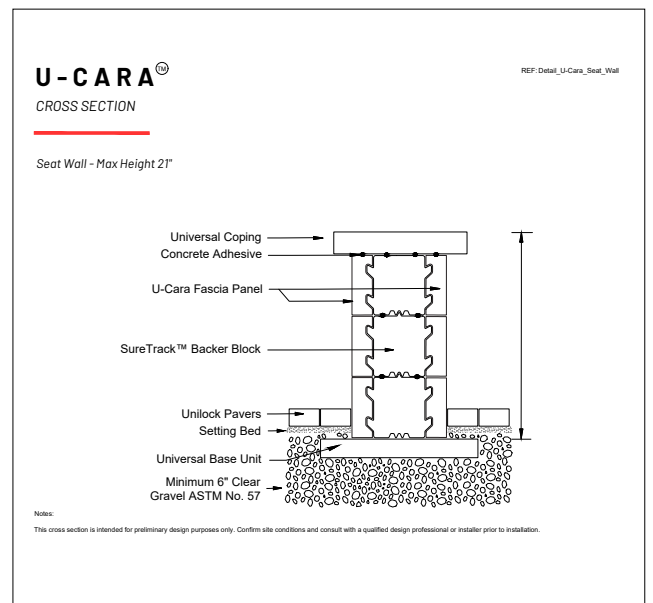
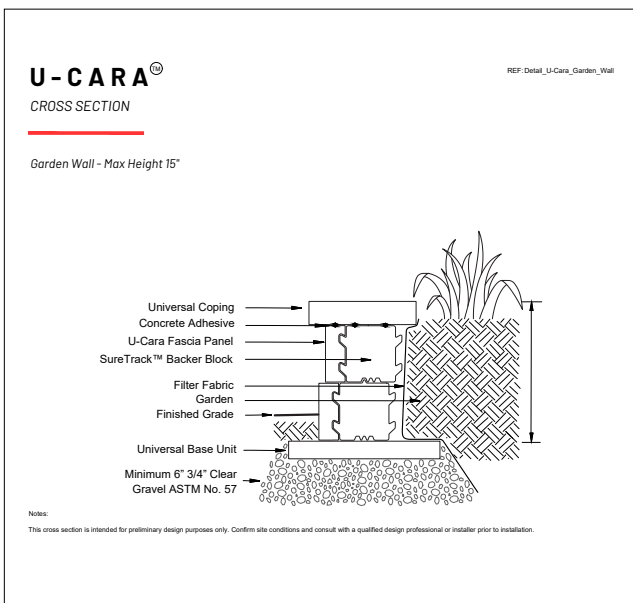
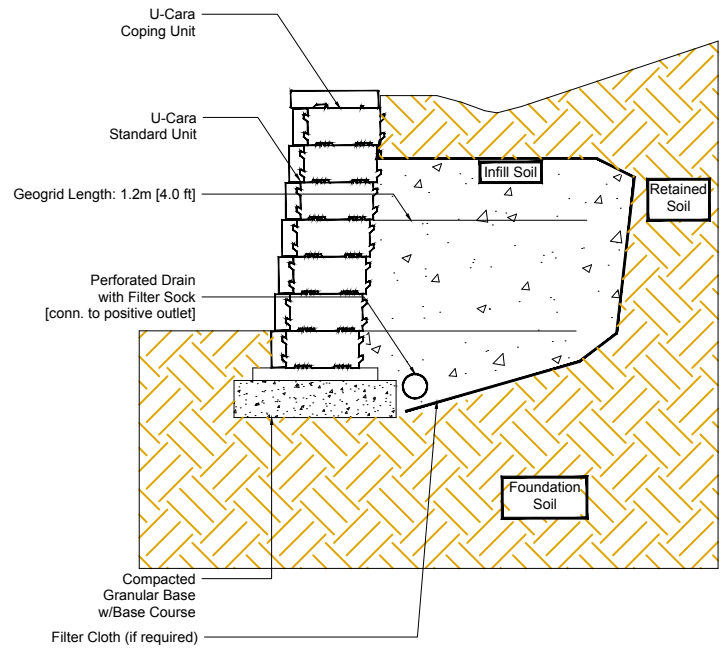

U-CARA RETAINING WALL GEOGRID SECTION

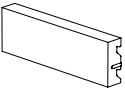
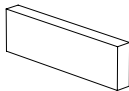

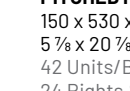
Fascia Panels		STANDARD SMOOTH	CLOSED-END SMOOTH	STANDARD UMBRIANO	CLOSED-END UMBRIANO	STANDARD PITCHED	CLOSED-END PITCHED
Bundle Type		SINGLE	MULTI	SINGLE	MULTI	SINGLE	MULTI
Plant Produced		CHICAGO	CHICAGO	GEORGETOWN	GEORGETOWN	CHICAGO	CHICAGO
Thickness (mm)		150 mm	150 mm	150 mm	150 mm	150 mm	150 mm
FCFT PER	Stone	0.73	-	0.73	-	0.73	-
	Layer	10.25	9.03	10.25	9.03	10.25	9.03
	Bundle	61.52	54.18	61.52	54.18	61.52	54.18
PER BUNDLE	Layers	6.00	6.00	6.00	6.00	6.00	6.00
LNFT PER	Unit	1.54	2.50	1.54	2.50	1.54	2.57
	Bundle	129.50	104.86	129.50	104.86	129.50	107.94
UNITS PER	SqFt	1.37	-	1.37	-	1.37	-
	Layer	14.00	7.00	14.00	7.00	14.00	7.00
	Bundle	84.00	42.00	84.00	42.00	84.00	42.00
LBS PER	Units	20	-	25	-	23	-
	Layer	275	207	344	207	317	236
	Bundle	1,648	1,241	2,067	1,240	1,904	1,416
Colors	Reflectance	Stock	Stock	Stock	Stock	Stock	Stock
Dark Charcoal	SR n/a SRI n/a	✓	✓	-	-	-	-
Bavarian	SR n/a SRI n/a	✓	✓	-	-	✓	✓
Fossil	SR n/a SRI n/a	✓	✓	-	-	✓	✓
Granite Fusion	SR n/a SRI n/a	✓	✓	-	-	✓	✓
Indiana Buff	SR n/a SRI n/a	✓	✓	-	-	-	-
Opal Blend	SR n/a SRI n/a	✓	✓	-	-	-	-
Oat Beige	SR n/a SRI n/a	✓	✓	-	-	-	-
French Grey	SR n/a SRI n/a	-	-	✓	✓	-	-
Grenada White	SR n/a SRI n/a	-	-	✓	✓	-	-
Midnight Sky	SR n/a SRI n/a	-	-	✓	✓	-	-
Summer Wheat	SR n/a SRI n/a	-	-	✓	✓	-	-
Winter Marvel	SR n/a SRI n/a	-	-	✓	✓	-	-

SINGLE UNIT BUNDLE		<p>STANDARD SMOOTH 150 x 466 x 60mm 5 7/8 x 18 3/8 x 2 3/8" 84 Units/Bundle .73 Fc.Ft./Stone</p>	<p>2 UNIT CLOSED-END BUNDLE</p> <p>SMOOTH & UMBRIANO</p>		<p>CLOSED-END FASCIA PANEL 150 x 530 x 60mm 5 7/8 x 20 7/8 x 2 3/8" 42 Units/Bundle 24 Rights & 18 Lefts 1.29 Fc.Ft./Stone</p>		<p>STANDARD FASCIA HALF PANEL 150 x 233 x 60mm 6 x 9 1/4 x 2 3/8" 42 Units/Bundle 1.29 Fc.Ft./Stone</p>	<p>2 UNIT CLOSED-END BUNDLE</p> <p>PITCHED</p>		<p>CLOSED-END PITCHED PANEL 150 x 530 x 72mm 5 7/8 x 20 7/8 x 2 3/8" 42 Units/Bundle 24 Rights & 18 Lefts 1.29 Fc.Ft./Stone</p>		<p>STANDARD PITCHED HALF PANEL 150 x 233 x 72mm 6 x 9 1/4 x 2 3/8" 42 Units/Bundle 1.29 Fc.Ft./Stone</p>
--------------------	---	---	---	---	---	---	--	---	---	--	---	---

Notes: SOLD IN FULL BUNDLES ONLY and is produced and sold on a required, refundable skid. Important: A urethane rubber paver mat must be used to prevent scuffing when compacting. All measurements are nominal. Contact Unilock for more information. STOCKED AT AURORA, ELKHORN & TONGANOXIE



APPLICATIONS

Pillar, Outdoor Kitchen, Water Feature, Fire Feature, Walls up to 3' in Height: Seat Wall, Garden Wall, Retaining Walls, Structural Wall

APPEARANCE

Surface Texture - Smooth, Standard, Umbriano Mottled and Pitched

TECHNICAL INFORMATION

Conforms to ASTM C1372

Eligible for LEED v4.1 credits

	LAVANO STANDARD	LAVANO CLOSED END/ HALF PANEL	SUBWAY STANDARD	SUBWAY CLOSED END/ HALF PANEL
Bundle Type	SINGLE	MULTI	SINGLE	MULTI
Plant Produced	CHICAGO	CHICAGO	CHICAGO	CHICAGO
Thickness (mm)	150 mm	150 mm	150 mm	150 mm

FCFT PER	Stone	0.73	-	0.73	-
	Layer	10.25	9.03	10.25	9.03
	Bundle	61.52	54.18	61.52	54.18

PER BUNDLE	Layers	6.00	6.00	6.00	6.00
------------	--------	------	------	------	------

LNFT PER	Unit	1.54	-	1.54	-
	Bundle	129.50	104.86	129.50	104.86

UNITS PER	SqFt	1.37	-	1.37	-
	Layer	14.00	7.00	14.00	7.00
	Bundle	84.00	42.00	84.00	42.00

LBS PER	Units	20	-	20	-
	Layer	275	207	285	226
	Bundle	1,648	1,241	1,709	1,359

Colors	Reflectance	Stock	Stock	Stock	Stock
Fossil	SR n/a SRI n/a	✓	✓	-	-
Granite Fusion	SR n/a SRI n/a	✓	✓	-	-
Indiana Buff	SR n/a SRI n/a	✓	✓	-	-
Dark Charcoal	SR n/a SRI n/a	-	-	✓	✓
Opal Blend	SR n/a SRI n/a	-	-	✓	✓

SINGLE UNIT

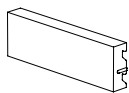

LAVANO STANDARD FASCIA PANEL
150 x 466 x 60mm
5⁷/₈ x 18³/₈ x 2³/₈"
84 Units/Bundle
.73 Sq.Ft./Stone

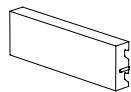

SUBWAY STANDARD FASCIA PANEL
150 x 466 x 70mm
5⁷/₈ x 18³/₈ x 2³/₈"
84 Units/Bundle
.73 Sq.Ft./Stone

2 UNIT CLOSED-END BUNDLE
LAVANO

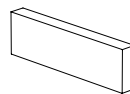

CLOSED-END FASCIA PANEL
150 x 530 x 60mm
5⁷/₈ x 20⁷/₈ x 2³/₈"
42 Units/Bundle
1.29 Sq.Ft./Stone



LAVANO STANDARD FASCIA HALF PANEL
150 x 233 x 60mm
5⁷/₈ x 9¹/₄ x 2³/₈"
42 Units/Bundle
.37 Sq.Ft./Stone

2 UNIT CLOSED-END BUNDLE
SUBWAY

SUBWAY STANDARD FASCIA HALF PANEL
150 x 233 x 70mm
5⁷/₈ x 9¹/₄ x 2³/₈"
42 Units/Bundle
.37 Sq.Ft./Stone

SUBWAY STANDARD FASCIA HALF PANEL
150 x 233 x 70mm
5⁷/₈ x 9¹/₄ x 2³/₈"
42 Units/Bundle
.37 Sq.Ft./Stone

Notes: SOLD IN FULL BUNDLES and is produced and sold on a required, refundable skid. Contact Unilock for more information. STOCKED IN AURORA, ELKHORN & TONGANOXIE

SMOOTH PANELS



BAVARIAN



FOSSIL



INDIANA BUFF

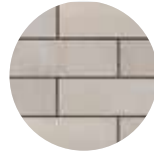

OAT BEIGE

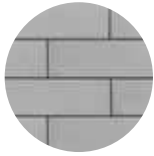

OPAL BLEND



GRANITE FUSION



DARK CHARCOAL

UMBRIANO® PANELS
Lead time required



FRENCH GREY



GRENADA WHITE



MIDNIGHT SKY



SUMMER WHEAT

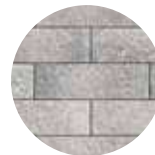

WINTER MARVEL

PITCHED PANELS



FOSSIL



GRANITE FUSION



BAVARIAN

SUBWAY PANELS



DARK CHARCOAL

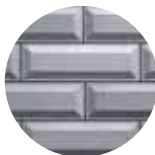

OPAL BLEND

LAVANO PANELS

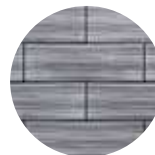

GRANITE FUSION

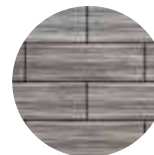

FOSSIL

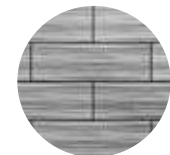

INDIANA BUFF

U-Cara® Backer



	CORNER BACKER	LARGE BACKER	STANDARD BACKER
Bundle Type	SINGLE	SINGLE	SINGLE
Plant Produced	CHICAGO	CHICAGO	CHICAGO
Thickness (mm)	150 mm	150 mm	150 mm

FCFT PER	Stone	0.28	0.32	0.32
	Layer	3.96	6.78	11.30
	Bundle	15.82	20.35	33.91

PER BUNDLE	Layers	4.00	3.00	3.00
------------	--------	------	------	------

LNFT PER	Unit	-	0.66	0.67
	Bundle	-	41.34	69.99

UNITS PER	SqFt	3.54	3.10	3.10
	Layer	14.00	21.00	35.00
	Bundle	56.00	63.00	105.00

LBS PER	Unit	37	44	23
	Layer	521	922	819
	Bundle	2,085	2,766	2,458

Colors	Reflectance	Stock	Stock	Stock
Natural	N/A	✓	✓	✓



NATURAL

COMPONENTS

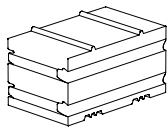

SURE TRACK CORNER BACKER
150 x 175 x 294mm
5 7/8 x 6 7/8 x 11 5/8"
56 Units/Bundle

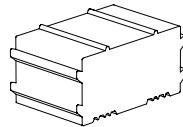

SURE TRACK LARGE BACKER
150 x 200 x 294mm
5 7/8 x 7 7/8 x 11 5/8"
63 Units/Bundle

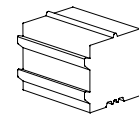

SURE TRACK STANDARD BACKER
150 x 200 x 150mm
5 7/8 x 7 7/8 x 5 7/8"
105 Units/Bundle

RECOMMENDED
BASE UNIT

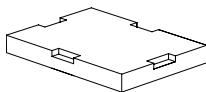

UNIVERSAL U-GRIP™ BASE
355 x 482 x 55mm
14 x 19 x 2 1/4"

See page 81 for more information

EXTRA
COMPONENTS



SURE TRACK CORNER INSERT
L = 2"
50mm
40 Inserts per bag
RS:ACC 245

Sold in full bags only

Notes: SOLD IN FULL BUNDLES ONLY and is produced and sold on a required, refundable skid. **Important: A urethane rubber paver mat must be used to prevent scuffing when compacting.** All measurements are nominal. Contact Unilock for more information.
Stocked at Aurora, Elkhorn & Tonganoxie

The U-Cara Modular System offers a variety of aluminum frames that can be mixed and matched to construct vertical features like grill islands. Speak to your contractor to select a design and a U-Cara fascia panel finish to suit your project.

With the U-Cara Modular System you can build Grill Islands, Bars, Back splashes, Fire Places and Pillars.

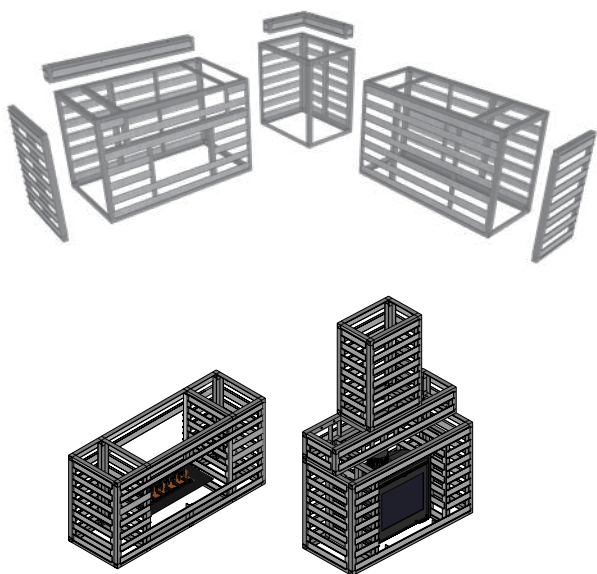

No.	MODEL	DESCRIPTION
RS-UCARA000001	URS	UCARA 8' RAIL (10/PACK)
RS-UCARA000002	URS	ALIGNMENT BARS 39" (10/PACK)
RS-UCARA000005	UL-HCK	HEIGHT CONVERSION KIT
RS-UCARA000006	UL-HCK-OS	HEIGHT CONVERSION KIT OVERSIZED
RS-UCARA000007	UL-OSK	OVERSIZED KIT
RS-UCARA000009	UL-FIR	FIREPLACE
RS-UCARA000010	UL-FIR-M	FIREPLACE MANTLE
RS-UCARA000014	UL-HCK-CC-OS	HEIGHT CONVERSION CORNER CABINET OVERSIZED
RS-UCARA000015	UL-HCK-CC	HEIGHT CONVERSION CORNER CABINET
RS-UCARA000016	UL-FIR-MW	FIREPLACE MANTLE WIDE UNIT
RS-UCARA000017	UL-FIR-CH	FIREPLACE CHIMNEY UNIT
RS-UCARA000018	UL-FIR-CH-MW	FIREPLACE CHIMNEY WIDE UNIT
RS-UCARA000019	UL-FIR-RTN	FIREPLACE RETURN
RS-UCARA000020	UL-FIR-RTN-OS	FIREPLACE RETURN OVERSIZED
RS-UCARA001000	UL-GC	UNIVERSAL GRILL CABINET (FITS 36-42" GRILL)
RS-UCARA002000	UL-BC	BASE CABINET (FITS FIRE TABLE OR FRIDGE)
RS-UCARA003000	UL-CC	CORNER CABINET 27.5" X 27.5"
RS-UCARA003001	UL-CC-OS	CORNER CABINET 27.5" X 36.5" OVERSIZED
RS-UCARA003002	UL-CC-BP	CORNER CABINET BACK PANEL
RS-UCARA004000	UL-ECK	END CLAD KIT 27.5"
RS-UCARA004001	UL-ECK-OS	END CLAD KIT 36.5" OVERSIZED
RS-UCARA005000	UL-BS	BACKSPLASH-GRILL/BASE UNIT 64½"
RS-UCARA005001	UL-BS-CC	BACKSPLASH CORNER CABINET
RS-UCARA005002	UL-BS-CC-OS	BACKSPLASH CORNER CABINET OVERSIZED
RS-UCARA007000	UL-PU	PILLAR UNIT (18 ¾" X 18 ¾")



U-Cara® Wall Mount System

ENDURACOLOR™



The U-Cara Wall Mount System allows you to put the finishing touches on your project by cladding existing structures like unsightly exposed foundation areas or concrete steps with U-Cara fascia panels.



U-CARA ALIGNMENT BAR
RS-UCARA000002
39" LENGTH - SOLD IN PACKS OF 10 PIECES

U-CARA RAILS
RS-UCARA000001
8' LENGTH - SOLD IN PACKS OF 10 PIECES



APPLICATIONS

Pillar, Water Feature, Pool Coping, Fire Feature, Wall Coping, Steps

APPEARANCE

Surface Texture - Smooth

TECHNICAL INFORMATION

Conforms to ASTM C 1372

Eligible for LEED v4.1 credits

	While Supplies Last		New for Spring 2026	
	24 x 14 CHAMFERED	24 x 14 FULLNOSE	24 x 14 CHAMFERED	24 x 14 FULLNOSE
Bundle Type	SINGLE	SINGLE	SINGLE	SINGLE
Plant Produced	MARENGO	MARENGO	MARENGO	MARENGO
Thickness (mm)	60 mm	60 mm	60 mm	60 mm

FCFT PER	Stone	-	-	-	-
	Layer	-	-	-	-
	Bundle	-	-	-	-

PER BUNDLE	Layers	10.00	10.00	5.00	5.00
------------	--------	-------	-------	------	------

LNFT PER	Unit	1.97	1.97	1.97	1.97
	Bundle	78.74	78.74	39.37	39.37

UNITS PER	SqFt	-	-	-	-
	Layer	4.00	4.00	4.00	4.00
	Bundle	40.00	40.00	20.00	20.00

LBS PER	Units	61	59	61	59
	Layer	242	235	242	235
	Bundle	2,423	2,350	1,211	1,175

Colors	Reflectance	Stock	Stock	Stock	Stock
Opal Blend	SR.n/a SRI n/a	✓	✓	✓	✓
Indiana Buff	SR.n/a SRI n/a	✓	✓	✓	✓
Dark Charcoal	SR.n/a SRI n/a	✓	✓	✓	✓



OPAL BLEND



INDIANA BUFF

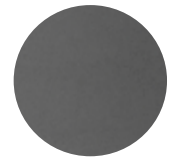

DARK CHARCOAL

SINGLE UNITS

While Supplies Last

24 x 14 CHAMFERED
600 x 355 x 60 mm
23 5/8" x 14 x 2 3/8"
40 units/Bundle

24 x 14 FULLNOSE
600 x 355 x 60 mm
23 5/8" x 14 x 2 3/8"
40 units/Bundle

SINGLE UNITS

Spring 2026

24 x 14 CHAMFERED
600 x 355 x 60 mm
23 5/8" x 14 x 2 3/8"
20 units/Bundle

24 x 14 FULLNOSE
600 x 355 x 60 mm
23 5/8" x 14 x 2 3/8"
20 units/Bundle

Notes: SOLD IN FULL BUNDLES ONLY and is produced and sold on a required, refundable skid. Accurate weights to come in Spring of 2026. Units can be adhered to pool edge using concrete adhesive, or with mortar. Always observe proper construction techniques when adhering pavers to a surface. Consult your local pool contractors for installation specifics. All measurements are nominal. Contact Unilock for more information.



APPLICATIONS

Pillar, Water Feature, Pool Coping, Fire Feature, Wall Coping, Steps

APPEARANCE

Surface Texture - Smooth

TECHNICAL INFORMATION

Conforms to ASTM C 1372

Eligible for LEED v4.1 credits

	35.5 x 19 CHAMFERED	35.5 x 19 FULLNOSE	28 x 28 PILLAR CAP
Bundle Type	SINGLE	SINGLE	SINGLE
Plant Produced	MARENGO	MARENGO	MARENGO
Thickness (mm)	60 mm	60 mm	60 mm

FCFT PER	Stone	0.58	0.58	-
	Layer	1.16	1.16	-
	Bundle	6.96	6.96	-

PER BUNDLE	Layers	6.00	6.00	4.00
------------	--------	------	------	------

LNFT PER	Unit	2.96	2.96	-
	Bundle	35.46	35.46	-

UNITS PER	SqFt	1.72	1.72	-
	Layer	2.00	2.00	-
	Bundle	12.00	12.00	4.00

LBS PER	Units	TBD	TBD	241
	Layer	TBD	TBD	241
	Bundle	TBD	TBD	966

Colors	Reflectance	Stock	Stock	Stock
Opal Blend	SR.n/a SRI n/a	✓	✓	✓
Indiana Buff	SR.n/a SRI n/a	✓	✓	✓
Dark Charcoal	SR.n/a SRI n/a	-	-	✓



OPAL BLEND



INDIANA BUFF



DARK CHARCOAL

SINGLE UNITS

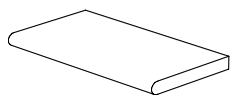

35.5 x 19 FULLNOSE
900 x 485 x 60 mm
35½ x 19 x 2⅜
12 units/Bundle
.58 Fc.Ft/Stone

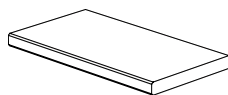

35.5 x 19 CHAMFERED
900 x 485 x 60 mm
35½ x 19 x 2⅜
12 units/Bundle
.58 Fc.Ft/Stone



28 x 28 PILLAR CAP CHAMFERED
711 x 711 x 60mm
28 x 28 x 2⅜"
4 units/Bundle

Notes: SOLD IN FULL BUNDLES ONLY and is produced and sold on a required, refundable skid. Accurate weights to come in Spring of 2026. Units can be adhered to pool edge using concrete adhesive, or with mortar. Always observe proper construction techniques when adhering pavers to a surface. Consult your local pool contractors for installation specifics. All measurements are nominal. Contact Unilock for more information.

Brussels Fullnose™ & Fullnose Edger



APPLICATIONS

Steps, Pillar, Water Feature, Pool Coping, Wall Coping, Fire Feature

APPEARANCE

Surface Texture:

Brussels Fullnose - Weathered

Fullnose Edger - Smooth

TECHNICAL INFORMATION

Conforms to ASTM C 936

LEED Eligible

EPD's & HPD's available

	BRUSSELS FULLNOSE	FULLNOSE EDGER
Bundle Type	SINGLE	SINGLE
Plant Produced	CHICAGO	CHICAGO
Thickness (mm)	60 mm	60 mm

SQFT PER	Stone	-	-
	Layer	12	-
	Bundle	120.00	104.00

PER BUNDLE	Layers	10.00	4.00
------------	--------	-------	------

LNFT PER	Unit	0.50	0.50
	Bundle	120.00	104.00

UNITS PER	SqFt	-	-
	Layer	-	52.00
	Bundle	240.00	208.00

LBS PER	Units	13	13
	Layer	316	698
	Bundle	3,160	2,791

Colors	Reflectance	Stock	Stock
Charcoal	SR .12 SRI 9	✓	✓
Limestone	SR .12 SRI 9	✓	✓
Sandstone	SR .41 SRI 46	✓	✓
Sierra	SR. n/a SRI n/a	✓	✓

BRUSSELS FULLNOSE



CHARCOAL

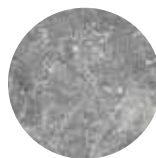

LIMESTONE



SANDSTONE



SIERRA

FULLNOSE EDGER



CHARCOAL



LIMESTONE



SANDSTONE



SIERRA

SINGLE UNITS

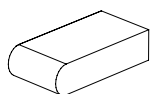

BRUSSELS FULLNOSE
150 x 300 x 60mm
5⁷/₈ x 11⁷/₈ x 2³/₈"
240 Units/Bundle

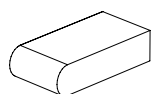

FULLNOSE EDGER
150 x 300 x 60mm
5⁷/₈ x 11⁷/₈ x 2³/₈"
208 Units/Bundle

Notes: SOLD IN FULL BUNDLES ONLY and is produced and sold on a required, refundable skid. Units can be adhered to pool edge using Unilock Concrete Adhesive, or with mortar. Always observe proper construction techniques when adhering pavers to a surface. Consult your local pool contractors for installation specifics. STOCKED AT AURORA, ELKHORN & TONGANOXIE

Ledgestone™ Coping & Closed-End Coping



APPLICATIONS

Steps, Water Feature, Pool Coping, Wall Coping, Fire Feature

APPEARANCE

Surface Texture - Textured

TECHNICAL INFORMATION

Conforms to ASTM C 1776

LEED Eligible

EPD's & HPD's available

	FULLNOSE COPING	ROCKFACE COPING	ROCKFACE CLOSED-END COPING	ROCKFACE LARGE COPING	ROCKFACE CLOSED-END LARGE COPING
Bundle Type	SINGLE	SINGLE	SINGLE	SINGLE	SINGLE
Plant Produced	CHICAGO	CHICAGO	CHICAGO	CHICAGO	CHICAGO
Thickness (mm)	60 mm	70 mm	70 mm	70 mm	70 mm

FCFT PER	Stone	0.39	0.46	0.46	0.57	0.57
	Layer	-	1.38	1.38	1.72	1.72
	Bundle	5.12	5.52	5.52	6.87	6.87

PER BUNDLE	Layers	-	4.00	4.00	4.00	4.00
------------	--------	---	------	------	------	------

LNFT PER	Unit	2.00	2.00	2.00	2.50	2.50
	Bundle	26.00	24.00	24.00	30.00	30.00

UNITS PER	SqFt	2.54	2.18	2.18	1.75	1.75
	Layer	-	3.00	3.00	3.00	3.00
	Bundle	13.00	12.00	12.00	12.00	12.00

LBS PER	Unit	56	64	66	94	93
	Layer	-	193	199	282	279
	Bundle	723	772	796	1,128	1,116

Colors	Reflectance	Stock	Stock	Stock	Stock	Stock
Buff	SR n/a SRI n/a	✓	✓	✓	✓	✓
Grey	SR n/a SRI n/a	✓	✓	✓	✓	✓

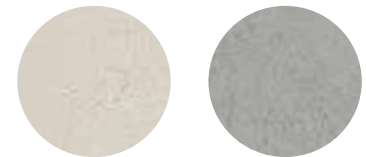

BUFF

GREY

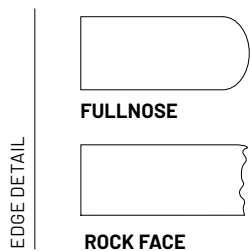

SINGLE UNITS

FULLNOSE COPING 610 x 305 x 60mm 24 x 12 x 2 3/8" 13 Units/Bundle .39 Fc.Ft./Stone	ROCKFACE COPING 610 x 305 x 70mm 24 x 12 x 2 3/4" 12 Units/Bundle .46 Fc.Ft./Stone	ROCKFACE CLOSED-END COPING 610 x 305 x 70mm 24 x 12 x 2 3/4" 12 Units/Bundle .46 Fc.Ft./Stone	ROCKFACE LARGE COPING 762 x 343 x 70mm 30 x 13 1/2 x 2 3/4" 12 Units/Bundle .57 Fc.Ft./Stone	ROCKFACE CLOSED-END LARGE COPING 762 x 343 x 70mm 30 x 13 1/2 x 2 3/4" 12 Units/Bundle .57 Fc.Ft./Stone

Notes: SOLD IN FULL BUNDLES ONLY and is produced and sold on a required, refundable skid. Coping is rock faced on the front and the back; Closed-end coping and steps are rock faced on three sides. All measurements are nominal. Contact Unilock for more information. **STOCKED AT AURORA, ELKHORN & TONGANOXIE**

Ledgestone™ Pillar Caps, Steps & Fire Pit Coping



	30" STEP TREAD	48" STEP	72" STEP	24" PILLAR CAP	29" PILLAR CAP	21 1/2" FIRE PIT COPING
Bundle Type	SINGLE	SINGLE	SINGLE	SINGLE	SINGLE	SINGLE
Plant Produced	CHICAGO	MULTI-PLANT	MULTI-PLANT	CHICAGO	CHICAGO	CHICAGO
Thickness (mm)	70 mm	150 mm	150 mm	100 mm	100 mm	65 mm

FCFT PER	Stone	0.57	1.97	2.95	-	-	-
	Layer	1.72	1.97	2.95	-	-	-
	Bundle	6.87	5.91	8.86	-	-	-

PER BUNDLE	Layers	4.00	3.00	3.00	5.00	5.00	6.00
------------	--------	------	------	------	------	------	------

LNFT PER	Unit	2.50	4.00	6.00	-	-	-
	Bundle	30.00	12.00	18.00	-	-	-

UNITS PER	SqFt	1.75	0.51	0.34	-	-	-
	Layer	3.00	1.00		1.00	1.00	4.00
	Bundle	12.00	3.00	3.00	5.00	5.00	24.00

LBS PER	Units	87	556		159	206	35
	Layer	262	556	813	159	206	141
	Bundle	1,049	1,669	2,439	795	1,030	843

Colors	Reflectance	Stock	Stock	Stock	Stock	Stock	Stock
Buff	SR n/a SRI n/a	✓	✓	✓	✓	✓	✓
Grey	SR n/a SRI n/a	✓	✓	✓	✓	✓	✓

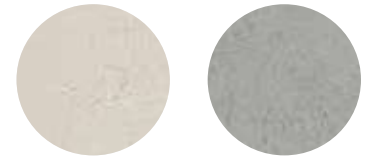

BUFF

GREY

SINGLE UNIT BUNDLE

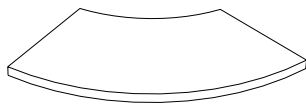

FIRE PIT COPING
254 x 546 x 65mm
10 x 21 1/2 x 2 5/8"
24 Units/Bundle

8 pieces per Fire pit,
Outside Diameter 54"
Inside Diameter 34"

SINGLE UNITS
PILLAR CAPS

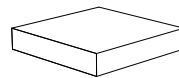

24"
610 x 610 x 100mm
24 x 24 x 3 7/8"
5 Units/Bundle
.66 Fc.Ft./Stone

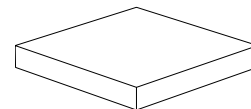

28"
740 x 740 x 100mm
28 1/2 x 28 1/2 x 4"
5 Units/Bundle
.66 Fc.Ft./Stone

SINGLE UNITS
STEPS

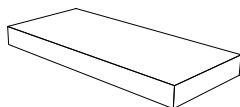

30"
762 x 343 x 70mm
30 x 13 x 2 3/4"
12 Units/Bundle
.57 Fc.Ft./Stone

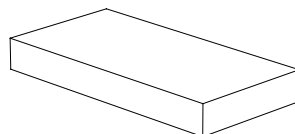

48"
1220 x 610 x 150mm
48 x 24 x 5 7/8"
3 Units/Bundle
1.97 Fc.Ft./Stone

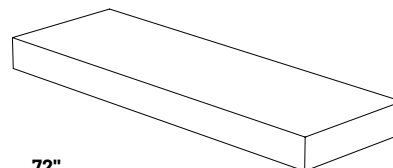

72"
1830 x 610 x 150mm
72 x 24 x 5 7/8"
3 Units/Bundle
2.95 Fc.Ft./Stone

Notes: **SOLD IN FULL BUNDLES ONLY** and is produced and sold on a required, refundable skid. Coping is rock faced on the front and the back; Closed-end coping and steps are rock faced on three sides. Firepit is sold separately from the coping bundle. All measurements are nominal. Contact Unilock for more information. **STOCKED AT AURORA, ELKHORN & TONGANOXIE**



APPLICATIONS

Pillar, Water Feature, Pool Coping, Fire Feature, Wall Coping, Steps

APPEARANCE

Surface Texture - Umbriano Mottled

TECHNICAL INFORMATION

Conforms to ASTM C 936
LEED Eligible
EPD's & HPD's available

	While Supplies Last	New for Spring 2026	
	24x14 FULLNOSE AND CHAMFERED	24x14 FULLNOSE AND CHAMFERED	24x14 CHAMFERED
Bundle Type	SINGLE	SINGLE	SINGLE
Plant Produced	MARENGO	MARENGO	MARENGO
Thickness (mm)	60 mm	60 mm	60 mm

FCFT PER	Stone	-	-	-
	Layer	-	-	-
	Bundle	-	-	-

PER BUNDLE	Layers	10.00	5.00	5.00
------------	--------	-------	------	------

LNFT PER	Unit	1.97	1.97	1.97
	Bundle	78.74	78.74	78.74

UNITS PER	SqFt	-	-	-
	Layer	4.00	4.00	4.00
	Bundle	40.00	20.00	20.00

LBS PER	Units	61	59	61
	Layer	242	235	242
	Bundle	2,423	1,175	1,211

Colors	Reflectance	Stock	Stock	Stock
French Grey	SR .18 SRI 17	✓	✓	✓
Grenada White	SR .45 SRI 52	✓	✓	✓
Midnight Sky	SR .17 SRI 15	✓	✓	✓
Summer Wheat	SR .42 SRI 48	✓	✓	✓
Winter Marvel	SR .35 SRI 38	✓	✓	✓



FRENCH GREY GRENADA WHITE MIDNIGHT SKY



SUMMER WHEAT WINTER MARVEL

SINGLE UNITS

While Supplies Last

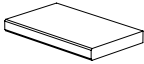

24x14 CHAMFERED
600 x 360 x 60 mm
24 x 14 x 2 3/8
40 Units/Bundle

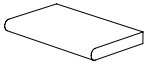

24X14 FULLNOSE
600 x 360 x 60 mm
24 x 14 x 2 3/8
40 Units/Bundle

SINGLE UNITS

Spring 2026

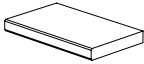

24x14 CHAMFERED
600 x 360 x 60 mm
24 x 14 x 2 3/8
20 Units/Bundle

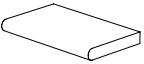

24X14 FULLNOSE
600 x 360 x 60 mm
24 x 14 x 2 3/8
20 Units/Bundle

Notes: SOLD IN FULL BUNDLES ONLY and is produced and sold on a required, refundable skid. Units can be adhered to pool edge using Unilock Concrete Adhesive, or with mortar. Always observe proper construction techniques when adhering pavers to a surface. Consult your local pool contractors for installation specifics. **Stocked at Aurora, Elkhorn, Marengo & Tonganoxie**



APPLICATIONS

Pillar, Water Feature, Pool Coping, Fire Feature, Wall Coping, Steps

APPEARANCE

Surface Texture - Umbriano Mottled

TECHNICAL INFORMATION

Conforms to ASTM C 936

LEED Eligible

EPD's & HPD's available

	36x19 CHAMFERED	36x19 FULLNOSE
Bundle Type	SINGLE	SINGLE
Plant Produced	MARENGO	MARENGO
Thickness (mm)	60 mm	60 mm

FCFT PER	Stone	0.58	0.58
	Layer	1.16	1.16
	Bundle	6.96	6.96

PER BUNDLE	Layers	6.00	6.00
------------	--------	------	------

LNFT PER	Unit	2.96	2.96
	Bundle	35.46	35.46

UNITS PER	SqFt	1.72	1.72
	Layer	2.00	2.00
	Bundle	12.00	12.00

LBS PER	Units	TBD	TBD
	Layer	TBD	TBD
	Bundle	TBD	TBD

Colors	Reflectance	Stock	Stock
French Grey	SR .18 SRI 17	SO	SO
Grenada White	SR .45 SRI 52	SO	SO
Midnight Sky	SR .17 SRI 15	SO	SO
Summer Wheat	SR .42 SRI 48	SO	SO
Winter Marvel	SR .35 SRI 38	SO	SO



FRENCH GREY



GRENADA WHITE

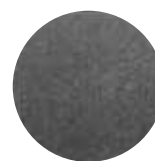

MIDNIGHT SKY



SUMMER WHEAT



WINTER MARVEL

SINGLE UNITS

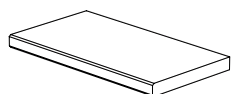

36 x 19 CHAMFERED
900 x 485 x 60 mm
35½ x 19 x 2¾
12 units/Bundle

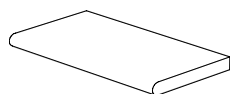

36 x 19 FULLNOSE
900 x 485 x 60 mm
35½ x 19 x 2¾
12 units/Bundle

Notes: Special Order, lead time required. SOLD IN FULL BUNDLES ONLY and is produced and sold on a required, refundable skid. Units can be adhered to pool edge using Unilock Concrete Adhesive, or with mortar. Always observe proper construction techniques when adhering pavers to a surface. Consult your local pool contractors for installation specifics.

Universal U-Grip™ Base



APPLICATIONS

Garden Wall, Retaining Wall under 3, Seat Wall, Fire Feature

APPEARANCE

Surface Texture - Standard / Smooth

TECHNICAL INFORMATION

Conforms to ASTM C 1372
LEED Eligible
EPD's & HPD's available

Bundle Type	SINGLE
Plant Produced	CHICAGO
Thickness (mm)	55 mm

FCFT PER	Stone	-
	Layer	-
	Bundle	-

PER BUNDLE	Layers	9.00
------------	--------	------

LNFT PER	Unit	1.58
	Bundle	85.50

UNITS PER	SqFt	-
	Layer	6.00
	Bundle	54.00

LBS PER	Units	47
	Layer	280
	Bundle	2,524

Colors	Reflectance	Stock
Natural	SR.n/a SRI n/a	✓



NATURAL

SINGLE UNITS

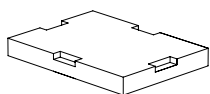

482 x 355 x 55mm
19 x 14 x 2 1/4"
54 Units/Bundle

Notes: SOLD IN FULL BUNDLES ONLY and is produced and shipped on a required, refundable skid. Coping bundle includes 2 End units per Layer (1 Left & 1 Right). All measurements are nominal. Contact Unilock for more information.
STOCKED AT AURORA, ELKHORN & TONGANOXIE

Sunset Fire Pit Kit



APPLICATIONS

Fire Feature

APPEARANCE

Surface Texture - Standard

TECHNICAL INFORMATION

Conforms to ASTM C 1372

LEED Eligible

EPD's & HPD's available

	SQUARE KIT	ROUND KIT
Bundle Type	SINGLE	SINGLE
Thickness (mm)	300 mm	300 mm

DIAMETER (inch)	Outside	56.00	52.00
	Inside	40.00	36.00
	Insert	38.00	34.00

LAYER PER UNIT	3.00	3.00
UNIT PER LAYER	16.00	18.00
UNIT PER PALLET	48.00	54.00

LBS PER PALLET	1,525	1,125
----------------	-------	-------

Colors	Reflectance	Stock	Stock
Granite	SR. n/a SRI n/a	-	✓
Sandstone	SR. n/a SRI n/a	✓	✓
Sierra	SR n/a SRI n/a	✓	✓

SUNSET FIRE PIT KIT	SQUARE	ROUND
Granite	-	RS-CON082
Sandstone	RS-CON037	RS-CON031
Sierra	RS-CON036	RS-CON030

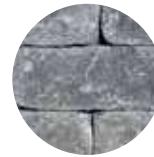

GRANITE



SANDSTONE



SIERRA

SINGLE KIT

Inserts can also be sold separately.



SUNSET ROUND KIT
1300 x 1300 x 300mm
51 1/4 x 51 1/4 x 11 7/8"



SUNSET SQUARE KIT
1400 x 1400 x 300mm
55 x 55 x 11 7/8"

Notes: All measurements are nominal. Packaged and Shipped on a required, refundable skid. Contact Unilock for more information. STOCKED AT AURORA, ELKHORN, MARENGO & TONGANOXIE

Unilock Elements

TUSCANY COLLECTION

TUSCANY FIREPLACE

Sandstone with Cophthorne® (3 Color Blend)



TUSCANY FIREPLACE

Sierra with Cophthorne® (3 Color Blend)



ELEMENT PRODUCT CODES

	Sandstone	Sierra
Fireplace Top	RS-ELE074-1	RS-ELE095-2
Fireplace Bottom	RS-ELE088-1	RS-ELE096-2
Wood box Set	RS-ELE028-1	RS-ELE027-1
Arched Hearth	RS-ELE016-1	RS-ELE017-1

WEIGHTS

Fireplace Top – 2925 lbs
 Fireplace Bottom – 4225 lbs
 Wood Boxes – 4005 lbs
 Arched Hearth – 1170 lbs

BARCELONA COLLECTION

BARCELONA FIREPLACE

Sierra with Umbriano® (Summer Wheat)



ELEMENT PRODUCT CODES

	Sierra
Fireplace	RS-ELE214
Wood box Set	RS-ELE213
Arched Hearth	RS-ELE212

WEIGHTS:

Fireplace Top – 2725 lbs
 Fireplace Bottom – 4170 lbs
 Wood Boxes – 4200 lbs
 Arched Hearth – 1200 lbs

NEW from Unilock, the SkyView Roof Deck System is a comprehensive product lineup that includes adjustable pedestals, invisible wind uplift solutions, roof deck slabs, wood tile, and fiberglass grate. Together, these components offer unmatched flexibility, empowering designers to create elevated rooftop spaces that are visually stunning, durable and high-performing. The system's intuitive design also simplifies installation for contractors, ensuring efficiency without compromising quality. With SkyView, reimagine what's possible for roof deck design and construction.

SKYVIEW PEDESTAL SYSTEM

Unilock SkyView Pedestals are patent pending, fully adjustable structural supports for elevating paving materials. Our pedestals ensure unmatched flexibility, ease of installation and durability.



- 1/2" and 1" Waffles available for low profile applications.
- 10" Cores and Collars available for taller applications up to 31".

SKYVIEW GRATE

When this 48 x 48" fiberglass grate is placed on SkyView Pedestals, it creates a stable surface for installing smaller paver units on an elevated roof deck.

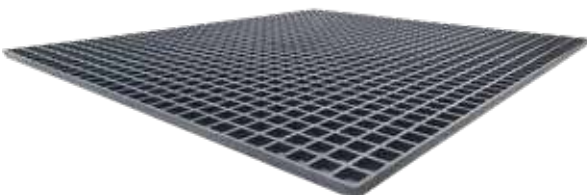

SKYVIEW WIND UPLIFT SYSTEM

When the below components are combined with the SkyView Pedestal System, they create a rafted paving surface with an invisible tie-down mechanism that resists wind uplift pressures without compromising project aesthetics.

1 | Wind Uplift Slabs

24 x 24" slabs featuring a kerfed undercut that spans the length of two opposing sides.

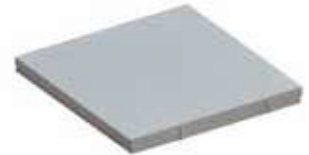

2 | Wind Uplift Kit

This 3-part kit is easily added to SkyView Pedestals to form a tie-down mechanism that works seamlessly with our Wind Uplift Slabs.



SCREW



KEYWAY
LOCKDOWN BAR



PUCK

SKYVIEW IPE WOOD TILE

Sustainably harvested and FSC certified, these 24 x 24" tiles have a dense hardwood composition that makes them perfect for use on SkyView Pedestals.



Ask your Unilock Representative about the made to order roof deck slab options available for your projects.

Cleaning Products



- PROFESSIONAL GRADE OIL & GREASE REMOVER**
RS-CLN001 1 quart; 6/case; 100 cases/skid (600 ea)
- Removes penetrated petroleum-based stains.
 - Clean-dries from a liquid to a powder.



- PAINT, TAR & RUBBER REMOVER**
RS-CLN007 1 quart; 6/case; 120 cases/skid (720 ea)
- Effectively dissolves paint, tar, rubber or chewing gum.
 - Water-rinsable stones, concrete, and masonry.



- PAVER RESTORER**
RS-CLN044 1 gallon; 4/case; 36 cases/skid (144 ea)
- Eco-friendly cleaner removes slurry and polymeric haze.
 - Cleans up to 200 sq. ft./gallon.



- SUREBOND SURECLEAN**
RS-CLN014 1 Gallon; 4/case; 36 cases/skid (27 cases/truckload - HAZMAT)
RS-CLN063 5 Gallon (SPECIAL ORDER) 36 ea./skid (25 ea./truckload - HAZMAT)
- Environmentally friendly, non-acid, super concentrated cleaner; requires dilution
 - Dislodges dirt, grime, tire scuffing and environmental soiling.
 - Cleans up to 250 sq. ft./gallon.
 - 1,000 lbs. HAZMAT weight restriction applies with this product.



- SUREBOND EFFLO OFF**
RS-CLN062 1 gallon; 4/case; 36 cases/skid (27 cases/truckload - HAZMAT)
RS-CLN067 5 gallons (SPECIAL ORDER) (25 ea/truckload - HAZMAT)
- Heavy-duty, non-acid concentrated cleaner; requires dilution
 - Designed for the removal of efflorescence, mineral and salt deposits.
 - Cleans up to 200 sq. ft./gallon.
 - 1,000 lbs. HAZMAT weight restriction applies with this product.



- SUREBOND STAIN & RUST BUSTER**
RS-CLN065 1 quart; 12/case; 36 cases/skid (432 ea)
- Environmentally friendly spot cleaner.
 - Cleans stains such as moss, mildew, leaf, rust and non-greasy food stains.
 - S.R.B. is concentrated; requires dilution prior to use.



- SUREBOND SURE STRIP**
RS-CLN031 1 gallon; 4/case; 36 cases/skid (144 ea)
RS-CLN032 5 gallons; 36/skid (SPECIAL ORDER)
- Strips away a variety of sealers and coatings.
 - Fast-acting, works in minutes.
 - Ready to use, no dilution needed.
 - Coverage is about 250 Sq. Ft./gallon.

Adhesive Products



- SUREBOND SB-10 ADHESIVE**
RS-ADH009-1 10 oz; 12/case; 140 cases/skid (1680 ea)
RS-ADH015-1 28 oz; 12/case; 60 cases/skid (720 ea)
- Fast set-up, quick curing.
 - Can be applied to wet, damp & frozen block.
 - Temperatures ranging from 0 - 100°F.
 - 900 psi.



- SUREBOND SB-15 ADHESIVE**
* LIMITED STOCK - SOLD IN FULL CASES ONLY*
RS-ADH050 10 oz tube; 12/case; 140 cases/skid
RS-ADH051 28 oz tube; 12/case; 60 cases/skid
- Rapid set, 70% faster set time.
 - Superior durability including heavy vehicular traffic.
 - Temperatures ranging from 10 - 100°F.
 - 1200 psi.



- ALLIANCE XP GATOR BLOCK ADHESIVE**
RS-ADH039 10 oz; 12/case; 90 cases/skid (1080 ea)
RS-ADH040 28 oz; 12/case; 60 cases/skid (720 ea)
- Bonds permanently in 24 hours.
 - Material may be repositioned for up to 30 minutes.
 - Works in temperatures above 32°F.
 - 850 psi in 24 hrs (1000 psi in 7 days).



- TECHNISEAL STRUCTURE BOND™ FOAM ADHESIVE**
RS-ADH048 24 oz; 12/case; 84 cases/skid (1008 ea)
- Super- strength foam adhesive.
 - Most items are bonded in just 8 minutes.
 - Works best in temperatures between 0- 120°F.
 - Yields up to 600 ln.ft. with a 3/8" bead.



- TECHNISEAL STRUCTURE BOND™ GUN II**
RS-TOOL378 1 dispenser gun; 12/case
- Perfect for hard-to-reach applications.
 - Limits excessive spillage or dripping.
 - Reusable: Easy clean-up using Gun Cleaner.



- TECHNISEAL STRUCTURE BOND™ GUN CLEANER**
RS-CLN093 24 oz/canister; 12 canisters/case
- Rapidly dissolves any uncured Structure Bond adhesive residue.



- TECHNISEAL STICKY STONE**
RS-ADH055 20.3 oz sausage; 15 sausages/case; 66 cases/skid. Sold in full cases only
- Professional-grade vertical hardscape adhesive.
 - Perfect for outdoor kitchens, fire pits & columns, etc.
 - Holds up to 15 lbs.
 - Coverage: 1/4" x 1/4" deep area, each sausage will cover 50 lnft.
 - Recommended to place 1/2" bead every 3".
 - Applies mess-free and easily with gun applicator.



- STICKY STONE GUN**
RS-TOOL557 1 dispenser gun kit; 10 kits/case
- Heavy-duty dispenser gun specially designed for Sticky Stone.
 - Each gun kit includes: 6 nozzles, 2 extra pistons & steel hook pull.

Note: Carefully read all instructions and safety information on product label prior to application. For additional safety information, see MSDS.

Sealing Products



BACK TO BLACK SEALER

RS-SEAL238 1 quart; 3 quarts/case

- Quickly revives and enhances faded, dark limestone.
- Provides stain & water-resistant surface.
- 1 Liter covers up to 400 sqft with one coat depending on surface porosity.
- LIMITED STOCK AVAILABLE



SUREBOND 8700 WET LOOK JOINT SAND STABILIZER WITH FUNGICIDE

RS-SEAL151 1 gallon; 4/case; 36 cases/skid (27 cases)

RS-SEAL152 5 gallons; 36 ea/skid (22 ea.)

RS-SEAL176 55 gallons; 4 drums/skid | SPECIAL ORDER (1-55 Gal Drum - HAZMAT Limit per TL)

- Seals & enhances surface while hardening jointing sand.
- Deeply enhances surface with stain-resistant semi-gloss finish.
- Formulated with antifungal to stop growth of mold, fungi and moss.
- Rain safe in 90 minutes; approx. coverage 80-120 sq.ft.
- 1,000 lbs. HAZMAT weight restriction applies with this product.



SUREBOND 4000 INVISIBLE PENETRATING

RS-SEAL033 1 gallon | RS-SEAL034 5 gallon

- Surface Penetrating
- Long Lasting & Durable
- Water repellant and salt blocker
- Non-Hazardous and VOC/EPA Compliant



SUREBOND 1300 JOINT SAND STABILIZING SEALER

RS-SEAL037-2 1 gallon; 4/case; 36 cases/skid (144 ea)

RS-SEAL036 5 gallon; 36 ea./skid

RS-SEAL038 55 gallons; 4 drums/skid (SPECIAL ORDER)

- Stabilizes joints, reduces sand washout, weeds & insects.
- Locks in with a clean, natural look & matte finish.
- Formulated with antifungal to protect film from mold, moss & algae.
- Approximate coverage 80 - 120 sq.ft.



TECHNISEAL® WL4 PROSERIES WET LOOK WATER REPELLANT

RS-SEAL001 1 gallon; 4/case; 45 cases/skid;

(22 cases/truckload - HAZMAT)

RS-SEAL073 5 gallons; 48 ea/skid;

- Solvent-based sealer to enhance pavers with wet-look, high-gloss finish.
- Reduces oil & dirt penetration, makes cleaning easier.
- Approximate coverage is 150 sq.ft./gallon (750 sq.ft./5 gallons).
- 1,000 lbs HAZMAT weight restrictions applies with this product.

Sand Products



SEK JOINTING SAND

RS-SAND001-1 Tan | RS-SAND140 Grey

RS-SAND186 Black | RS-SAND148 Platinum

50 lb/bag • 56 bags/skid (2860 lbs/skid)

- Recommended for joints up to 3/4".
- Angular jointing sand, washed, screened & kiln-dried.
- Coverage: 50=75 Sq. Ft./bag with standard 1/4" joints.



SEK POLYSWEEP SAND

RS-SAND045 Tan | RS-SAND046 Grey

RS-SAND184 Black | RS-SAND147 Platinum

RS-SAND232 Pearl

50 lb/bag • 56 bags/skid (2860 lbs/skid)

- Recommended for joints up to 3/4".
- Haze Free Guaranteed - Advanced Clear Set Technology.
- Coverage 50-75 Sq.Ft./bag with standard 1/4" joints.



SEK POLYSWEEP SAND X-TREME WIDE JOINT

RS-SAND111 Tan | RS-SAND117 Grey

RS-SAND185 Black | RS-SAND149 Platinum

50 lb/bag • 56 bags/skid (2860 lbs/skid)

- Formulated for joints 1/8" up to 4".
- Haze Free Guaranteed - Advanced Clear Set Technology.
- Coverage 50-75 Sq.Ft./bag with standard 1/4" joints.



TECHNISEAL HP NEXTGEL

RS-SAND241 Tan | RS-SAND133 Urban Grey

(Ships from Nebraska Plant)

RS-SAND130 Prairie Grey | RS-SAND131 Prairie Tan

(Ships from Montreal Plant - Only Available in IA, NE, MO & SD)

50 lb/bag • 56 bags/skid (2860 lbs/skid)

- Dust & haze-free, fast-setting polymeric sand.
- Formulated for heavy-sloped, heavy traffic, high humidity and pool decks.
- For joints from 1/16" to 4", ideal for joints up to 1".
- Coverage: 60-120 Sq.Ft./bag for narrow joints.

**Direct loads of sand can't be mixed across different manufacturing plants.*



ALLIANCE GATOR SUPER SAND

RS-SAND078 Beige | RS-SAND080 Slate Grey

50lb bag / 56 bags per skid

- Advanced haze-free polymeric sand.
- Formulated for pavers, slabs & wet cast pavers up to 1".
- Rain safe 1 hour after water activation.
- Coverage: 65-85 Sq.Ft./bag with joints 1/8" to 3/8".



ALLIANCE SUPER SAND G2

RS-SAND156 Beige | RS-SAND157 Slate Grey

50 lb/bag 56 bags/skid

- Intelligent polymeric sand to neutralize haze and dust.
- Formulated for joints up to 4" for traditional and up to 2" for overlay applications.
- Rapid Set Technology - Rain safe 16 minutes after water activation.
- Coverage: 65-85 Sq.Ft./bag with joints 1/8" to 3/8".

Note: Carefully read all instructions and safety information on product label prior to application. For additional safety information, see MSDS.

Sand Products continued



ALLIANCE GATOR DUST

RS-SAND072 – Beige | RS-SAND073 – Grey
50 lb./bag • 56 bags/skid

- Polymeric stone dust.
- Formulated for joints from 1/2" to 6".
- Ideal with Gator Base application.
- Coverage: 20-39 Sq.Ft./bag with joints 1" to 2".



ALLIANCE MAXX G2

RS-SAND158 – Beige | RS-SAND159 – Slate Grey |
RS-SAND160 – Black Diamond | RS-SAND161 – Ivory
Packaging: • 50 lb./bag • 56 bags/skid

- Intelligent polymeric sand to neutralize haze and dust.
- Formulated for joints up to 4" for traditional applications & up to 2" for overlay applications.
- Rapid Set Technology – Rain safe 16minutes after water activation.
- Coverage: 65-85 Sq.Ft./bag with joints 1/8" to 3/8".



ALLIANCE EUROSTONE

RS-SAND095 – Slate Grey

- Polymeric sand designed for drainage and non-drainage base systems.
- Formulated for joints up to 1.5".
- Works above 32°F.
- Coverage 65-85 Sq.Ft./bag with joints 1/8" to 3/8".

Permeable Chip Products



ALLIANCE GATOR AQUA ROCK

RS-AGG032 – 50lb./bag • 56 bags/skid
RS-AGG033 2200 lb./Super Sack

- Meets ASTM No. 9 requirement for permeable joint units.
- High-strength granite ideal for bedding course & jointing material.
- Coverage: 20-25 Sq.Ft./bag | 880-1100 Sq.Ft./ Super Sack.



SEK PERM CHIPS

50lb./bag • 56 bags/skid

RS-AGG035 – Eclipse Black | RS-AGG040 – Stormy Grey
RS-AGG037 – Saturn Tan (SPECIAL ORDER/FULL SKID ONLY)

2500 lb Super Sack:

RS-AGG036 – Eclipse Black | RS-AGG039 – Saturn Tan
RS-AGG041 – Stormy Grey

- High-strength crushed and washed granite meets ASTM No. 9 Stone Specifications for permeable joint filler
- Ideal for permeable paving stone installations, both as a bedding course and as a joint filler
- Coverage: 30-35Sq.Ft./bag | 1500-1750 Sq.Ft./Super Sack

Resin Sand Products



ALLIANCE GATOR NITRO SAND

RS-SAND196 Beige | RS-SAND197 Grey
RS-SAND198 Black | RS-SAND236 Silver (LSA)
40 lb bucket • 48 buckets/skid

- Ready to use permeable jointing material.
- Can be installed in wet or dry weather.
- Formulated for joints from 1/2" to 2".
- Ideal for concrete & wetcast pavers, Natural Stone & Porcelain Tile.
- Coverage: 10-84 Sq.Ft./bucket depending on joint width.



GATOR NITRO-X FINE JOINT

RS-SAND244 Black | RS-SAND245 Gunmetal
RS-SAND248 Taupe | RS-SAND247 Platinum
RS-SAND246 Vanilla
27.5 lbs Pail; 48 Pails/Pallet

- Rapid Flow Technology
- Fast and simple installation
- Xtra Fine gradation jointing sand
- Xtra Low permeability
- Xtra Strength from top to bottom ***
- Apply rain or shine
- Joint width from 1/8" to 2" (3 mm to 50 mm)****
- 5-year limited warrantywidth.

*** Gator Nitro-X Fine Joint Sand will harden from top to bottom up to 2 3/8" (60 mm).

**** Ensure there is ABSOLUTELY NO paver, porcelain tile or stone movement prior to installation to prevent joint cracking.



PS-1500 HYDROSWEEP REACTIVE RESIN JOINT SAND

RS-SAND251 Sandstone | RS-SAND252 Granite
RS-SAND254 Ebony | RS-SAND259 Ivory

- Ideal for Walkways, Patios, Pool Decks & Residential Driveways
- New Industry Standard in Resin Sands: Stronger & More Durable
- Ready-To-Use & Easy to Install
- Haze & Dust Free
- Install Rain or Shine
- Permeable

Geotextiles and Fabric Products

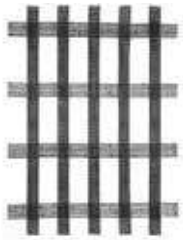

STRATAGRID - SGU60 RS-FAB101

- Geogrid reinforcement for soil and aggregates
- Engineered to be mechanically & chemically durable in harsh construction and aggressive soil environments
- Roll Dimensions: 6.25' wide x 288' length (200 Square Yards)
- 85 lbs/roll



UNILOCK DRIVEGRID™ SYSTEM RS-FAB104

- 120' x 12.5' Roll - 1,500 Sq. Ft.
- 56 lbs per roll.
- Sold in full rolls only.



GEOTEXTILE FABRIC RS-FAB001

- 6 oz. Non-woven multipurpose geotextile fabric.
- Sold in full roll quantities only.
- Roll Dimensions: 15' wide x 300' length (4500 Sq.Ft.)
- 225 lbs/roll.



ALLIANCE GATOR GRID 30-30

RS-FAB070 - 4'x50'; 15 rolls/case; 4 cases (60 rolls/skid) (FULL CASES ONLY)

RS-FAB072 - 6'x150'; 30 rolls/skid

- Biaxial geogrid, with high molecular weight weight and high-tenacity polyester yarns
- High-tenacity polyester yarns woven in tension and finished with PVC coating



GATOR FABRIC GF4.4

RS-FAB044 - 4'x100'; 6 rolls/case; 4 cases (24 rolls/skid) (FULL CASES ONLY)

RS-FAB047 - 6'x300'; 16 rolls/skid

- Needle punched non-woven geotextile made of polypropylene fibers
- Non-biodegradable and resistant to most soil chemicals.



GATOR FABRIC POLYSPUN 20 SPECIAL ORDER

Gator Fabric Polyspun 20 geotextile is specially formulated to resist deterioration in garden and landscape applications. It creates a barrier to reduce weed growth and allows water, fertilizer and air to pass through.

- Packaging:**
- 3' x 50' / 16 rolls per case / 64 rolls per skid
 - 3' x 100' / 9 rolls per case / 36 rolls per skid
 - 4' x 100' / 9 rolls per case / 36 rolls per skid
 - 6' x 100' / 30 rolls per case / 36 rolls per skid

Miscellaneous Items



WALL DRAIN PRO

RS-ACC086 Black | RS-ACC123 Grey
RS-ACC122 Tan

12 units/case; 63 cases/skid (full cases only)

- Simpler, aesthetically pleasing improved water drainage product
- Drain height can be easily modified to use with any block height under 8"



X & T SLAB SPACERS

RS-ACC237 X Spacers; 2" x 2"; 250 pcs./bag

RS-ACC236 T Spacers; 2" x 1"; 250 pcs./bag

- Unilock recommends using slab spacers when installing Arcana on an open grade surface
- "T" spacers are needed for running bond patterns; "X" spacers for stack bond patterns. Please contact your sales manager for more information
- X & T bagged separately



When figuring spacer quantity needed:

*Using T-Spacers for running bond pattern

Divide total SqFt by 1.78

*Using X-Spacers for stack bond pattern

Divide total SqFt by 3.56

Stainless Steel Fireplace Insert

STAINLESS STEEL FIREPLACE INSERT

36" Unit - RS-FIR033; Order with RS-FIR041 (18" Flue Pipe), RS-FIR042 (36" Flue Pipe) & RS-FIR036-1 (Termination Cap)

42" Unit - FS-FIR034; (LIMITED AVAILABILITY); Order with RS-FIR042 (36" Flue Pipe) & RS-FIR036-1 (Termination Cap)

- Outdoor, Wood-burning Fireplace.
- Insert comes with refractory panels, mesh spark screen and solid steel log grate.
- 254 lbs./Full Kit



	36	42
A	29"	36"
B	11-3/4"	11-3/4"
C	41"	48"
D	21"	24"
E	35"	42"
F	37"	41"
G	21"	22-1/2"

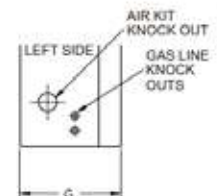
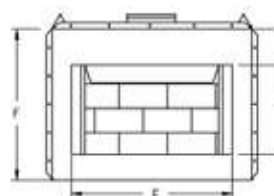
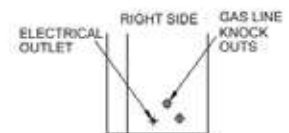
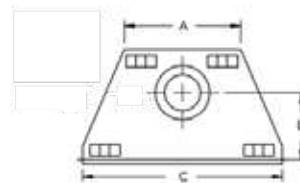

Edging Products



PERMAEDGE PAVER EDGING

RS-EDGE081 - 50 lb. bag; 56 Bags/Pallet

- Quick & easy to use - cuts install time by 75%.
- The perfect combination of strength, flexibility and permeability.
- Mix 2/3 gallon of water per bag.
- Approximate Coverage: 16' - 18' Ln.Ft. on Dense Base, 12' - 16' Lin. Ft on Open Graded Base.

PERMAPACK

RS-EDGE087 - Perma Pak 1 lb Packets

- Extreme flexural strength
- Water stop technology
- Shrink control
- Void Reduction
- Macro Synthetic Fibers
- Coverage:

Open graded base: 1 Perma Pak/50-60# bag of concrete will produce 12'-16' open graded/clear base (chip bedding)

Dense Base: 1 Perma Pak/50-60# bag of concrete will produce 17'-21' dense/crushed base (sand bedding)

- Packaging:
1 Perma Pak (1 lb. per packet)
1 Box of Perma Paks (30 packets per box - 31 lbs.)
1 Skid (32 boxes/960 packets - 1030 lbs.)



ALLIANCE GATOR EDGE RIGID

RS-EDGE055 8' piece; 24 pcs/bundle
28 bundles/pallet (672 pcs/pallet)

- Gator Edge Products are easy to use and quick to install. Offers great lateral support and makes definition easier for alleys, driveways or sidewalks.
- They are made with 100% polypropylene or polyethylene for strength and flexibility.
- Rigid Edging can be transformed to Flex with a simple cut.

ALLIANCE GATOR XTREME EDGE

RS-EDGE076 50 lb bag / 56 bags per skid.

- The ultimate fiber-reinforced structural edging solution for any hardscape project.
- Can be used for any traditional, open-graded, permeable, Gator Base or overlay application using concrete pavers or slabs, natural and wet cast stones.
- Offers permanent continuous lateral support.
- Approximate Coverage: 20-25 sqft. per bag.



SEK EDGECRETE

RS-EDGE075 - 50lb bag; 56 bags/skid

- Paver restraint in a bag - Just Add Water.
- Fiber-reinforced concrete edge restraint.
- Simple to install - No spikes needed.
- Approximate coverage: - Std. Base - 17 Ln.Ft./bag; Permeable & Open Base- 13 Ln.Ft./bag

EZ SET

RS-ACC500 - SB SEK EZ SET (TRASS BEDDING)
RS-ACC501 - SB SEK EZ OVERLAY (DRY MORTAR)
RS-ACC528 - SB SEK EZ BOND #50

- Trass-Blend Fiber Reinforced
- Creates a Rigid Structural Setting Bed
- Promotes Internal System Drainage
- Reduces Freeze/Thaw Damage
- Helps Minimize Efflorescence
- Easy To Install
- Mixes Onsite with 3/8" Angular, Clear Stone



SEK SNAPEDGE

RS-EDGE001 - 8' (96") piece; 24 pcs./bundle; 28 bundles (672 pcs)/skid

- One-piece edging system that handles both straight & curved installations.
- Unique and quick snip 'n flex feature.
- Open base design allows root and grass system to grow through.
- Standard Sidewall: 1 7/8" | Low Profile Sidewall: 1 3/8"
- Skid Dimensions: 98"L x 48"W x 50"H - 210 lbs./skid



SPIKES

RS-EDGE014 - 10" Round Spike; About 150 spikes/case; 48 cases/skid

- Premium heavy-duty landscape metal spike.
- SOLD IN FULL CASES ONLY.
- 51 lbs./case; 2,448 lbs./skid

Turf products



Alliance xTurf Products	Premium Blend		Classic Blend		Putting Green
Colors	Forest Green	Lime Green (SO)	Forest Green	Lime Green (SO)	Summer Green
Roll Sizes	7.5x25' (RS-TURF003)	7.5x25' (RS-TURF007)	7.5x25' (RS-TURF011)	7.5x25' (RS-TURF015)	7.5x25' (RS-TURF018)
	7.5x50' (RS-TURF004)	7.5x50' (RS-TURF008)	7.5x50' (RS-TURF012)	7.5x50' (RS-TURF016)	15x25' (RS-TURF017)
	15x33' (RS-TURF002)	15x33' (RS-TURF006)	15x33' (RS-TURF010)	15x33' (RS-TURF014)	
	15x100' (RS-TURF001)	15x100' (RS-TURF005)	15x100' (RS-TURF009)	15x100' (RS-TURF013)	
Pile Height	1.75" (45mm)		1.58" (40mm)		.63" (16mm)
Face Weight oz./Sq. Yd.	85 oz.		47 oz.		50 oz.

RS-TURF019	Gator X-Turf Infill Beige 50lb
RS-TURF020	Gator X-Turf Infill Green 50lb
RS-TURF021	Gator X-Turf Infill Zeo-White 40lb

RS-TURF022	Gator X-Turf Nails Spiral 6"
RS-TURF023	Gator X-Turf Seam Tape Roll 12x100
RS-TURF024	Gator X-Turf Seam Tape Roll 12x300
RS-TURF025	Gator X-Turf XP Odor Remover 27oz 12/case



- No Mowing, No Watering
- High Quality artificial Turf
- 20 limited year warranty



GATOR XTURF INFILL SAND GATOR BEIGE

RS-TURF019 Beige | RS-TURF020 Green
RS-TURF021 Zeo-White

- Holds artificial turf in place (1.5-3.0 lb/ft²)
- Ideal gradation for drainage
- Keeps artificial turf cooler
- Engineered for all artificial turf
- Natural product
- Safe for pets
- Environmentally safe
- Mesh size 20-40
- Permeable

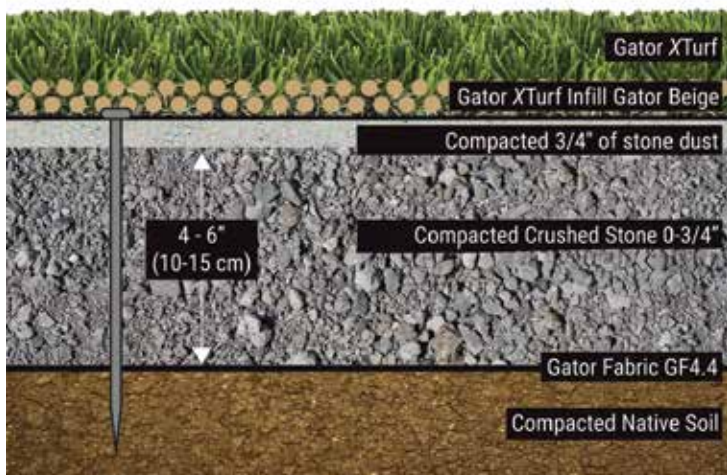

Unilock Pedestal System

TECHNICAL SPECIFICATIONS

Material	Recycled Polypropylene
Height Range	11/16" - 37-3/8" (17mm to 950mm)
Ultimate Compressive Strength ¹	P Series - 20 kN (4,496 lbs)* T Series - 10 kN (2,360 lbs)* M Series - 15 kN (3,372 lbs)*
Slope correction	0% to 8% @ 1% increment
Base Diameter	P Series - 6.81" (173 mm) T Series - 6.96" (177 mm) M Series - 8.26" (210 mm)
Spacer Tab Height	7/16" (11mm)
Spacer Tab Thickness	1/8" (3mm) [gap between pavers]
Biological / Chemical	Unaffected by molds and algae
Resistance	Good resistance to alkali and bitumen

¹Detailed values for individual heights are given in the technical specification

MAX PEDESTAL ASSEMBLY

ELEMENTS

Gap spacers
Gap spacers create spaces between paver tiles with 3 mm width.

Screw
Units have graduating heights.

Adjustment ring for height regulation
Adjustment ring allows easy and smooth pedestal height adjustment.

Base
Wide pedestal base for better support. Bases have different heights depending on unit.

OPTIONAL ACCESSORIES

Rubber shim
Noise reduction shim. Can also be divided into parts.

Self levelling head
Self levelling head automatically reduces surface slope up to 7%.

Height coupler (use up to 3)
Additional Height couplers can be added to increase pedestal height.



UNILOCK PEDESTAL HEIGHT CHART

T Series are discontinued. Limited quantities available while supplies last. Contact Unilock for more information.

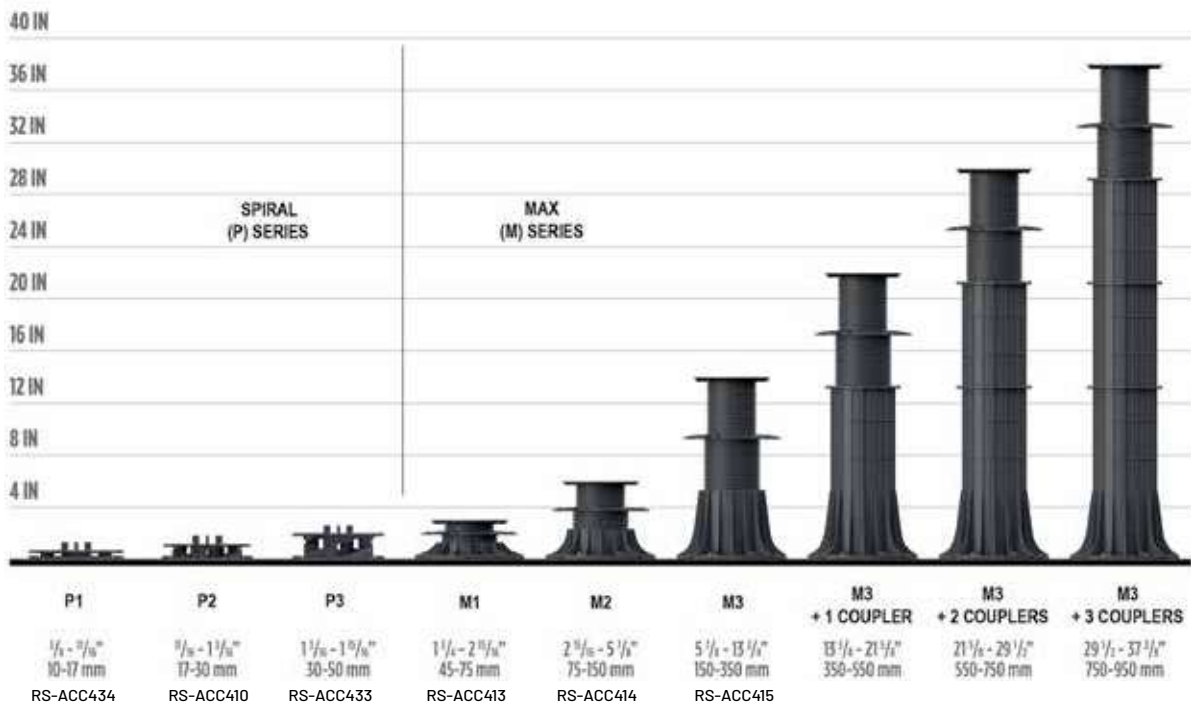

NOTE: These units are created using a combination of M1, M2 & M3 units. Contact Unilock for more information.

ACCESSORIES

	Moveable Gap Spacer Tabs 1/8" (3MM)	Self-leveling Head 6% MAX	Rubber Shim 1/16" (1.5MM)	Height Coupler 7 7/8" (200MM)	Slope Corrector 5/8" (16MM)	Drill Driver	Regulation Key	Wall Edge Clip 1/32" (0.7MM) SPECIAL ORDER
✓ Indicates compatible with Series ¹ , ordered tely. - Indicates not compatible with Series.								
	RS-ACC410	RS-ACC417	RS-ACC421	RS-ACC416	RS-ACC418	RS-ACC422	RS-ACC419	RS-ACC450
SPIRAL (P) SERIES	Gap Spacers Included	✓	✓	-	-	-	-	✓
MAX (M) SERIES*	Gap Spacers Included	✓	✓	✓	✓	✓	✓	✓

Gator Base System

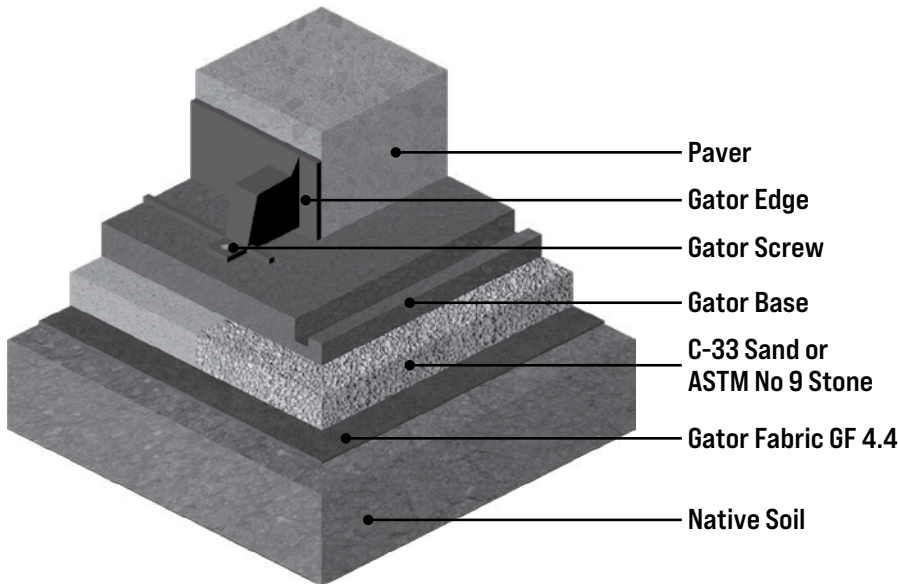

STEP 1 • EXCAVATION FOR THE GATOR BASE INSTALLATION

The total depth required will be determined by adding the thickness of the sand or chip setting bed (3/4" [19 mm]), GATOR BASE (3/4" [19 mm]), and thickness of the paver, slab, stone, or porcelain tile. Excavation depth is approximately 4" for a 2 3/8" [60 mm] concrete paver. Excavate 6" (15 cm) wider than the perimeter of the paved surface or 12" wider (30 cm) when building a seating wall or fire pit.

STEP 2 • LEVELING AND COMPACTING OF THE SOIL

The bottom of the excavated area should be uniform and smooth (+/- 3/8" [10 mm] in 10') and slope in the same direction as the finished paver surface. Compact the soil using a vibrating plate or hand tamper in confined areas.

STEP 3 • ADD GATOR FABRIC GF4.4 AND INSTALL SETTING BED

Cover the bottom and sides of the excavated area with Gator Fabric GF4.4. Spread an even layer of sand (ASTM C33 Concrete Sand) or chip (ASTM No. 9 Stone) in a 3/4" [19 mm] thick layer over the Gator Fabric GF4.4. No compaction is needed for the chip stone. However, the sand-setting bed should be compacted using a hand tamper or vibrating plate. It will help to moisten the sand before compaction. The surface should be smooth, the finished paver surface will mirror the grade set in this step.

STEP 4 • INSTALL THE GATOR BASE

Cover the area with the GATOR BASE panels, 6" (15 cm) wider than the finished paver edge or 12" (30 cm) for a seating wall or fire pit. Lay the GATOR BASE units in an alternating (staggered) pattern - if the Gator Faces line up, the interlocking edges will align perfectly. Gator Base can easily be cut to size using a utility knife.

STEP 5 • INSTALL PAVERS, BLOCKS AND GATOR EDGE

Place the pavers or blocks directly on the GATOR BASE. Adding a 1/2" (13 mm) of bedding sand onto the surface of the GATOR BASE is also an accepted method for non-uniform thickness stone. Install the Gator Edge on the GATOR BASE, firmly against the pavers or blocks. Use a Gator Base Screw every second edging hole to maximize the lateral support provided by the Gator Edge.

STEP 6 • APPLY GATOR MAXX G2 TO PAVER JOINTS

Gator Tile System

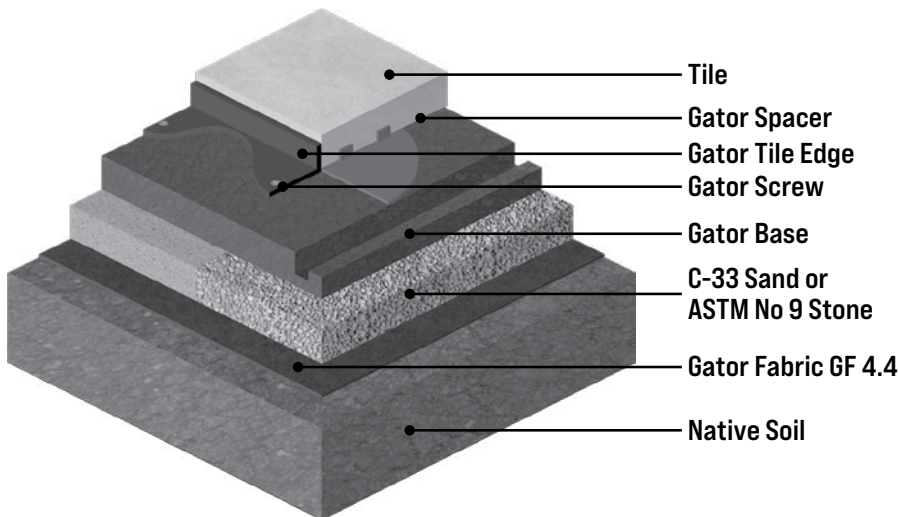

FOLLOW STEPS 1 TO 4 OF GATOR BASE SYSTEM

STEP 5 • INSTALL GATOR SPACER, GATOR XP GLUE AND TILE

The installation of porcelain tile directly on top of the Gator Base using the GATOR SPACER to provide uniform spacing and unparalleled stability. The GATOR SPACER has been designed to provide the right support, load transfer and a monolithic surface binding all units together with the help of the Gator XP Glue on every quadrants of the Gator Spacer.

STEP 6 • INSTALL GATOR TILE EDGE

Install the Gator Tile Edge on the GATOR BASE, firmly against the tiles. Use a Gator Base Screw every second edging hole to maximize the lateral support provided by the Gator Tile Edge.

STEP 7 • APPLY GATOR NITRO TO TILE JOINTS



Sealer Best Practices

- The paver surface should be **clean** and free from oil, dirt, dust and any loose material. This ensures a uniform result and allows the sealer to better penetrate the surface.
- The pavers should be **free of any visible efflorescence**.
- If pavers have been sealed before, make sure to resealed with compatible product.
- **Surface must be dry** (48 hours without precipitation) and warm to the touch (morning).
- Joint sand must also be dry.
- Make sure lawn sprinklers are shut off.
- Best air temperature is between **50 degrees to 80 degrees** with no rain forecasted for the next 24 hours.
- It is best to apply product under constant weather conditions and use the **same application method from start to finish**.
- The paver joints should be completely filled with dry correctly-graded joint sand. The top level should not exceed the bottom of the chamfer or **1/8" below** the surface on the non-beveled or tumbled paver surface.
- **Always test the product** on a small hidden area to ensure the results will meet your expectations.
- Always show homeowners samples to ensure expectations.

At this point read all sealer instructions and determine the best sealer for your desired goal. Do you want to retain the original look, enhance the color, or stabilize the sand joint?

- **Read application information as each sealer can be applied differently.**
- **Make sure you have the correct equipment based on type of sealer. Solvent based sealers need solvent resistant sprayers, watering cans or paint trays.** Water base sealers can be generally applied using plastic equipment. Example: solvent based sealers come in metal containers and water based sealers come in plastic containers.
- Care should be taken that no excess sealer material is pooled on the surface during application always back roll. When using solvent based sealers make sure roller is solvent resistant or for all paints. Foam rollers work best and are less likely to pull sand from the joints.
- Stabilizing sealers are generally sprayed or flood coated with a watering can, then back rolled.
- Acrylic non-stabilizing sealers can be sprayed, then back rolled or rolled on using a metal paint tray.
- **Send your most experienced worker to do sealing projects.**

Polysand Best Practices

- Ensure that paver surface has **proper drainage runoff** (Min 1" over 8'). Finished paver height should always be higher than grade to allow proper surface drainage.
- **Do not set pavers in limestone screenings.** This product holds moisture and does not meet the gradation, drainage qualities or strength of coarse concrete sand.
- Make sure pavers are **clean of all construction dust**. Residual construction dust will haze pavers!
- **Compact pavers** into setting bed to create proper interlock.
- Read and review all polysand manufacturers methods of application. **(Read Directions)**
- **Don't rush polysand installation.**
- Paver area must be completely dry.
- Lay bags of polysand over paver area. **Stage bags** in areas of coverage. Example: one bag for 60 square feet.
- **Do not over sweep sand.** Sweep sand back and forth within coverage area to fill paver joints.
- Compact sand into joints. This is a must in achieving proper density of the sand joint (repeat 3 times). Compaction is critical to assuring sand strength.
- Do not fill sand above the chamfer of paver. Sand should sit 1/8" below bottom of chamfer.
- Use a fine-bristle broom to **remove any excess sand from the paver surface**.
- Use a **leaf blower** remove any sand or binder residue.
- **Review all watering directions (each manufacturer has different watering instructions.) This is VERY IMPORTANT!**
- Always start watering at the **bottom of the slope**.
- Always start watering in **controlled areas** per manufacturers recommendations. Example: complete watering in 200 sq. ft. area then move on to the next 200 sq. ft. and repeat.
- During final watering of poly sand, **clean surface by removing excess water** with leaf blower or squeegee depending on paver surface texture. This will remove any leftover binder residue or sand.
- Final thoughts – Always be aware of the weather when installing poly sand. **(Temperature and setting time ratings differ between products.)**
- Refer to all manufacturers websites for installation videos.

2026 Freight Rates

Rates are based on a 0-50 mile radius from Aurora, IL, Marengo, IL & Elkhorn, WI facilities. Please contact the shipping department for all truckload rates and any questions concerning delivery. Approximately 14 bundles or 43,000 pounds per truckload. Delays incurred on delivery in excess of one hour will be billed to the purchaser at \$80 per hour or a fraction thereof. Partial load deliveries in excess of one-half hour will be billed to the purchaser at the same rate. **Fuel surcharge will be added to each order per guide below:**

Bundles	Boom	Princeton	Cost of Fuel	Flat Surcharge	At Least	Less Than	Fuel Surcharge
1-7	\$460.00	\$550.00	\$2.30 to \$2.79	\$27.00	\$2.30	\$2.79	5%
8-14	\$625.00	\$735.00	\$2.80 to \$3.29	\$42.00	\$2.80	\$3.29	10%
			\$3.30 to \$3.79	\$51.00	\$3.30	\$3.79	15%
			\$3.80 to \$4.29	\$64.00	\$3.80	\$4.29	20%
			\$4.30 to \$4.79	\$78.00	\$4.30	\$4.79	25%
			\$4.80 to \$5.29	\$93.00	\$4.80	\$5.29	30%
			\$5.30 to \$5.79	\$106.00	\$5.30	\$5.79	35%

Fuel Surcharge for 0-50 miles only

Fuel Surcharge for deliveries over 50 miles

NOTE: Rates are based on current economic conditions and are subject to fuel surcharges, which will be based on the U.S. National Average Midwest rate of diesel fuel, calculated weekly. When the average price of fuel rises (or drops), the surcharge will take effect the following Monday. These rates can be located at www.eia.gov/petroleum/gasdiesel/.

Important notes

SPECIAL ORDER PRODUCTS

Products listed as "Special Order" are not currently inventoried and may require additional lead times for manufacturing (or transfer from other Unilock locations). Prior to bidding or quoting projects, confirm Special Order unit pricing and minimum quantity requirements. A signed "Special Order Release Form" must be submitted prior to manufacturing and all material must begin shipping within 30 days of manufacturing date. Any Special Order products remaining at Unilock after 30 days will be subjected to a storage fee of \$5.00 per pallet per month. (Maximum storage is 3 months.) All quantities listed on the Special Order Release Form must ship and be paid in full. Please contact your Territory Manager for more information.

SPECIAL SAND GUIDANCE

EXTRA CARE must be exercised when using Polymeric Sand on the following products:

Arcana Courtstone® Copthorne® Il Campo® Richcliff® Series™ Town Hall® Tribeca Cobble Umbriano™

Polymeric Jointing Sand can be used on these products but the fine polymers and binders in Polymeric Jointing Sand have a natural tendency to adhere to the surface and therefore extra diligence must be taken to pre-clean the surface prior to "wetting the sand in" and squeegee off the surface post application. Failure to do so will result in a "whitish haze" on the surface that is difficult to remove.

IMPORTANT COMPACTION NOTICE: Always pre-compact the pavers WITHOUT SAND IN THE JOINTS. This will facilitate proper leveling. Polymeric sand can then be swept into the joints. Always use a compactor with a protective membrane attached to the bottom of the plate.

Polymeric Jointing Sand, cleaners and sealers, must always be applied by a trained and experienced professional. Contact your local Unilock office for training and the most up-to-date best practices.

NOTICE: Unilock does not accept any responsibility for damage to the surface caused by the improper application and use of polymeric sand, sealers or cleaners. Please refer to each individual manufacturer for full instructions prior to install.

NATURAL STONE INSTALLATION GUIDELINES

A slurry coat, sometimes called a bond or milk sealer coat, is brushed on to the back of each natural stone unit prior to installation in order to limit moisture penetration, prevent staining and aid adhesion.

OPTIMAL COLOR BLENDING INSTALLATION

Blending colors from multiple (3+) bundles is ideal for the optimal color installation. **DO NOT LAY PALLET TO PALLET!**

Important notes continued

UNILOCK PAVER PATTERNS

This Product Data Guide contains an extensive reference to patterns and designs. The purpose of these pattern swatches is to help the designer plan unique and exceptional designs. The percentages of products shown are based on the pattern and not on bundle configurations. In fact, there may be situations in which a pattern has been created with one particular size of stone, but that stone only comes packaged with two other sizes. This means that the designer will have to plan how the other components are used in the overall plan. This is usually accomplished by adding a border or an accent. As a result, overages or shortages may occur in certain patterns. The designer and/or installer of Unilock products accepts all responsibility for design and all associated costs incurred as a result of applying any of Unilock's suggested design patterns in a project. Please plan your project and review your order carefully prior to ordering.

TRANSFERABLE LIFETIME GUARANTEE

Unilock provides a Transferable Lifetime Guarantee* on the structural integrity of Unilock concrete paving stones and retaining wall units when used in residential applications. Any materials installed and maintained to our guidelines, and subject to normal wear, that prove defective, will be replaced without cost. Color matching cannot be guaranteed and replacement labor is not included. Proof of purchase is required.



Scan for full Guarantee details

*Transferable Lifetime Guarantee: Register your project within 60 days of your dated proof of purchase to ensure your Unilock Guarantee is fully transferable! Simply go online at unilock.com and follow instructions. Once processed, you will receive an original Transferable Warranty Certificate for your records.

PRODUCT HANDLING WARNING

Bundle Straps Under Tension – Use extreme caution when removing or handling straps. Always wear gloves, goggles, safety footwear, and protective clothing when removing or handling straps. Failure to do so may result in serious bodily injury or loss of sight.

Cut all concrete products only in well ventilated areas. Inhalation of dust is a serious health risk. A "NIOSH" (US) or a "CSA" (CDN) approved respirator, safety goggles, hearing protectors, and gloves must be worn at all times. Always "wet-cut" or "wet grind" concrete products to minimize dust.

Do not stack bundled concrete products higher than 2 bundles high. Contents of the bundle may be unstable and subject to topple when stacked. Always use extreme caution and appropriate equipment when transporting or storing bundled concrete products. Failure to do so may result in serious bodily injury or death. Always obey gross vehicle weight (GVW) loading limitations and regulations.

Hazard Rating: Fire 0, Health 1, Reactivity 0. See MSDS Concrete Masonry (Pavers). Contact Unilock for complete sheet or view safety information at Unilock.com.

Unilock assumes no liability or responsibility for loss or damage, resulting from the improper use or handling of our products, or from failure to follow instructions, warnings, and/or advisories on the product label, and on the MSDS sheet.

TRADEMARK & LEGAL INFORMATION

Umbriano® is a trademark of Metten Stein + Design GmbH & Co KG used under license by Unilock. Unilock Ltd. and Hengestone Holdings, Inc. are the owners or authorized users of all trademarks used in this publication unless otherwise specified.

Colors shown in this brochure should be used only as a guide. Colors should always be chosen from actual samples. Contact your local Unilock representative for color availability in your area. Not all products shown are available at all Unilock locations. Log on to www.unilock.com for availability. Measurements throughout this portfolio are nominal.

©2025 Hengestone Holdings, Inc.

Terms and Conditions of Sale

STANDARD TERMS

1. All orders are accepted subject to prevailing state or other taxes, and subject to applicable skid charges and the cost of freight applying at the time of shipment. Confirm prices at time of order as they are subject to change.
2. The acceptance by the seller of an order shall constitute a binding contract of purchase and sale, in accordance with the terms set out in this agreement.
3. These terms and conditions, together with the purchase order, form the complete contract, and there are no representations, warranties, or conditions expressed or implied, affecting this contract, other than as contained herein.
4. All sales are made in accordance with the seller's samples, which the purchaser has seen and approved. No guarantee of exact color shades is made.
- 5. Use of any materials delivered by or on behalf of the purchaser shall be deemed to constitute acceptance of the materials by the purchaser.**
6. Excessive defective material picked up or delivered to the purchaser will be replaced free of charge if a claim is made within five days. Free replacement will be the extent of the seller's warranty. Any such claim will not constitute a reason for delaying payment. All other claims must be submitted within 30 days of purchase.
7. Unsuitable or unsatisfactory materials must be available for inspection by the seller to entitle the purchaser to any adjustment or credit. Skid returns will be posted to account next business day.
8. No materials may be returned for credit except with the written consent of the seller, whether such materials were ordered in excess of the purchaser's requirement, by mistake, or otherwise. Where the seller agrees to accept the return of goods, these goods are subject to freight charges and a restocking charge of 20% of their value. All goods must be returned in their original packaging. ACCESSORIES, SECTIONS AND OPENED MATERIAL ARE NONRETURNABLE FOR ANY REASON.
9. Seller does not accept responsibility for delays in deliveries due to fire, flood, strikes, or any other condition or contingencies beyond its control.
10. The purchaser is responsible for installation of the materials on the job site, and the seller has no responsibility in this regard.
11. All approved credit accounts are payable within thirty days of invoice. After 30 days, interest will be charged at 1.5%* per month (A.P.R.19.65%*), Calculated monthly on the balance owing at the beginning of the period. If purchaser defaults in the payment of any portion of amounts due on account, the entire remaining unpaid balance shall, at the option of the seller, immediately become due and payable with collection costs incurred.
12. Skid deposits are nonrefundable with 2 or more broken top boards or one main stringer board. If you have skids loaded onto your vehicle or receive a delivery with skids in this condition, you must have the Unilock representative (loader or truck driver) note the quantity on the shipping document paperwork. The responsibility of the return of empty skids for credit rests with the purchaser. There will be a net usage fee for all skids accepted for return. Skids picked up by Unilock in conjunction with a delivery by a Unilock truck will not be credited until returned to Unilock and sorted and verified by Unilock. Normal delivery charges will apply to requested skid pickups which do not coincide with a Unilock delivery to the site.
13. A sectioning charge of \$30.00 is applied to all items where bundles are split.

GENERAL TERMS

1. All prices are F.O.B. Aurora, IL, Marengo, IL or Elkhorn, WI. Please contact Unilock for all freight rates.
2. All C.O.D. orders must be paid by certified check, cash, or prior approved check. Cashier's checks are encouraged over cash due to COVID19.
3. Contact Unilock for shipping schedules, rates, and conditions, and any fuel surcharges.
4. Configurations may vary from time to time due to mold design changes.
5. Delays incurred on delivery in excess of one hour will be billed to the purchaser at \$80.00 per hour or fraction thereof. Similarly, delays incurred on partial delivery (17 bundles) in excess of onehalf hour will be billed to the purchaser at the same rate.
6. There is a mandatory \$30 skid deposit charge for Skids (SKIDPREM 1,2,3,4 & 5), which are refundable when returned in good condition (a \$3.00 usage fee will be charged). All skid returns will be credited and posted to account the next business day.

CUSTOM ORDERS

1. Custom Orders, referred to as "Special Orders", are nonstandard, noninventoried items. Deposits of up to 100% of the order value (minimum of 20%) will be required. Minimum quantities apply on Special Orders and are subject to a [500] sq.ft. overrun charge. Purchase orders as well as a signed special order release form, or signed quote, will be required for Special Order material. Special Orders will not be accepted for return.
2. All SpecialOrder products must be shipped within 30 days of production. After 30 days all customproduced material will be subject to a storage fee of \$5.00 per pallet per month. Please contact your Territory Manager for more information.
3. The purchaser is responsible for full payment on unshipped SpecialOrder products within 30 days of the last shipment date or the completion of the product installation. The purchaser will be billed for the remaining material if the product shipments become inactive for a period of six (6) weeks or more.
4. Deposits are required and are nonrefundable and can be only applied to the aforementioned order.

CONFIRM ALL PRICES AS THEY ARE SUBJECT TO CHANGE

LIMITED WARRANTY:

Unilock's Internal Testing Suggests That The Skyview Wind Uplift System Can Significantly Reduce The Likelihood Of Rooftop Paver Failure Or Damage Due To Strong Wind Conditions; EXCEPT AS EXPRESSLY PROVIDED HEREIN, UNILOCK MAKES NO REPRESENTATIONS OR WARRANTIES WHATSOEVER WITH RESPECT TO THE PRODUCTS, WHETHER EXPRESS OR IMPLIED. WITHOUT LIMITING THE GENERALITY OF THE FOREGOING, UNILOCK HEREBY DISCLAIMS ALL OTHER WARRANTIES, INCLUDING THE IMPLIED WARRANTIES OF MERCHANTABILITY OR FITNESS FOR ANY PARTICULAR PURPOSE. SPECIFICALLY, UNILOCK DOES NOT REPRESENT OR WARRANT THAT ITS ROOFTOP PEDESTAL SYSTEMS OR ITS ROOFTOP TILES, SLABS OR PAVERS WILL REMAIN IN PLACE IN ALL HIGH WIND CONDITIONS.

LIMITATION OF LIABILITY:

EXCEPT AS OTHERWISE EXPRESSLY SET FORTH HEREIN, IN NO EVENT SHALL UNILOCK BE LIABLE TO BUYER FOR ANY DIRECT, INCIDENTAL, INDIRECT, SPECIAL, PUNITIVE, EXEMPLARY, TORT OR CONSEQUENTIAL DAMAGES, INCLUDING BUT NOT LIMITED TO ANY DAMAGES FOR BUSINESS INTERRUPTION OR THE LOSS OF REVENUES, PROFITS OR SAVINGS, WHETHER OR NOT SUCH DAMAGES WERE FORESEEN, UNFORESEEN OR FORESEEABLE, EVEN IF UNILOCK HAS BEEN ADVISED OF THE POSSIBILITY OF SUCH DAMAGES. NOTWITHSTANDING THE FOREGOING, IN THE EVENT THE TERMS OF THIS SECTION, OR ANY PART THEREOF, SHALL BE HELD BY A COURT OF COMPETENT JURISDICTION TO BE INVALID OR UNENFORCEABLE, UNILOCK'S TOTAL AGGREGATE LIABILITY TO BUYER WITH RESPECT TO THE PRODUCTS SHALL NOT EXCEED THE PURCHASE PRICE OF THE PRODUCTS GIVING RISE TO THE CLAIM. NOTWITHSTANDING THE FOREGOING, THIS SECTION SHALL NOT RELIEVE UNILOCK FROM LIABILITY FOR DAMAGES THAT RESULT FROM UNILOCK'S OWN GROSS NEGLIGENCE OR WILLFUL OR TORTIOUS ACTS.

Unilock Finishes

When considering the finish, think about the look you are trying to achieve as well as practical performance. From traditional smooth and flagstone, to enhanced surfaces, modern granite looks and timeworn patina, Unilock offers it all.

SMOOTH FINISH



Sometimes, simple is best. A smooth surface suits contemporary styles and is available in a wide variety of shapes for paving and verticals.

FLAGSTONE FINISH



Popular for centuries, a flagstone finish never fails to add warmth to outdoor spaces.

ANTIQUED FINISH



A variety of methods are used to achieve this distressed finish, but in every case, it lends a relaxed, rustic vibe.

TIMEWORN



Our exclusive Elegance line offers the look of centuries-old cobblestone, brick, and natural stone with unsurpassed product durability.

BRUSHED FINISH



Only Unilock offers Il Campo®, a unique surface enhanced with graphically interesting etched lines. This finish has long been a favorite of commercial designers.

UMBRIANO



Umbriano is an exclusive finish only available from Unilock with color and granite particles that are randomly dispersed to achieve a unique mottled surface that is reminiscent of granite.

EXPOSED GRANITE

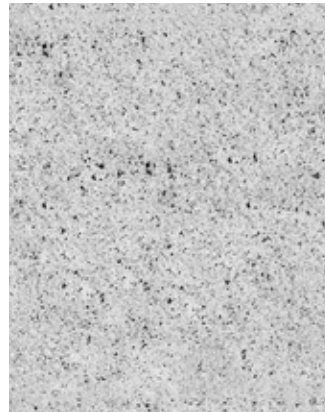

Granite, Quartz and Marble particles are embedded in the product's surface and then revealed using additional processing methods.

ENHANCED SURFACE



The surface of these products is enhanced using a special process to reveal a variety of distinctive colors and textures.

Color Blend Descriptions

COLOR NAME	DESCRIPTION
Alabaster	Cool, Neutral Grey
Artic Grey	White with black flecks
Autumn Red	Buff, Charcoal, and Red
Avorio	Beige with brown and white flecks
Basalt	Blue-Black
Bavarian Blend	Brown, Cream and Charcoal
Belgian Blue	Blue-Grey
Biscotti	Soft Beige with warm brown accents
Buff	Tan
Burgundy Red	Plum with Red
Burnt Clay	Brown with Red
Charcoal	Charcoal
Charleston	Yellow, Red, Charcoal
Coastal Slate	Grey, Tan
Cobalt Grey	White, Grey, and blue hues
Cocoa Brown	Solid DK Brown
Coffee Creek	Sandstone, Brown, Charcoal
Corvara	Grey with white flecks
Dark Charcoal	Dark Charcoal
Dawn Mist	Grey and Tan
Dusk	Grey, Tan and White
Ferrano	Cream base with black and brown flecks
Fieldstone	Buff, Grey, Light Charcoal
Fossil	Light & Dark Grey, Chamois, and White
French Grey	Light Grey with White flecks
Golden Tan	Dark Brown, Light Brown with White Granite
Granite	Charcoal and Natural
Granite Fusion	Charcoal and Natural
Grenada White	White with Grey specks
Graphite	Black and Grey
Heritage Brown	Brown and Red Brown
Indiana Buff	Creamy Ivory
Ivory	Cream
Light Granite	Light grey with black and white flecks
Light Opal Blend	Light Grey and White
Light Steel Grey Blend	Light and Mid Grey
Limestone	Light Tan, Charcoal
Linen Buff	Light Grey and Buff
Linen Grey	Light Buff and Grey
Midnight Charcoal	Charcoal, Black
Midnight Sky	Charcoal with Black Flake
Modena	White with Black flecks

COLOR NAME	DESCRIPTION
Natural Grey	Grey
Nevada	Natural, Tan, Beige
Nordic Star	Black with White flecks
Notte	Mid Charcoal, White and Light Natural
Oat Beige	Beige, White
Old Oak	Red Brown
Onyx Black	Dark Charcoal with Black Granite
Opal Blend	Light Grey and White
Pebble Taupe	Tan and Brown
Peppered Granite	White aggregates with black flecks
Platinum	Beige Cream with cool grey tones
River	Buff, Natural and Charcoal
Sabia	Brown, Black and Light Natural
Sable Blend	Cream, Tan and Brown
Sandstone	Buff and Tan
Scuro	Mid Grey with Tan flecks
Sierra	Buff, Brown, Charcoal
Silver Grey Blend	Light Grey
Smoke Shale	Charcoal and Dark Charcoal
Steel Blue	Blue-Grey
Steel Moutnatin	Grey and Cream
Sterling	Tan, Grey
Summer Wheat	Cream White w/ Pale Yellow & Beige flecks
Toscana Beige	Tan with brown & white flecks
Vivanto	Dark Grey with black and white flecks
Walnut	Light and dark brown
Winter Marvel	White with Black Flake
Tuscany	Sandstone and Tan

UNIT PAVERS

PRODUCT	FINISH	PEDESTRIAN	RESIDENTIAL VEHICULAR	COMMERCIAL VEHICULAR	ENVIRONMENTAL	FOR BORDERS & ACCENTS
ADA Paver	S	✓				
Anchorlock™	S	✓		✓		
Arcana™	SM	✓				
Artline™	M	✓	✓			
Beacon Hill™ Flagstone	F	✓				
Beacon Hill™ Smooth	SM	✓				
Bristol Valley®	F	✓				
Brussels Block®	W	✓	✓			✓
Cophthorne®	T	✓	✓			✓
Courtstone®	T	✓	✓			✓
Eco-Hex™	S	✓	✓	✓		
Eco-Line®	M	✓	✓	✓	✓	✓
Eco-Optiloc™	M	✓	✓	✓	✓	
Eco-Priora™	M	✓	✓	✓	✓	
Eco-Promenade EcoTerra™	WS	✓	✓			
Eco-Promenade®	M	✓	✓	✓	✓	
Granito™	F/SM	✓	✓	✓		
Hollandstone™	S	✓	✓	✓		✓
Holland Premier™	SM	✓	✓			✓
Mattoni™	SM	✓	✓			✓
Natural Stone	SM	✓				
Nordic Cobble™	WS	✓	✓	✓	✓	✓
Optiloc®	M	✓	✓	✓		
Porcelain	SM	✓				
Promenade®	M	✓	✓	✓		✓
Richcliff®	T	✓	✓			✓
Series™	WS	✓	✓	✓		✓
Skyline™	S	✓				
Soreno™	SM	✓				
Town Hall®	T	✓	✓	✓	✓	✓
Treo® Smooth	SM	✓	✓		✓	✓
Tribeca Cobble™	WS	✓	✓	✓	✓	✓
Turfstone™	S		✓	✓	✓	
Umbriano™	SM	✓	✓	✓	✓	✓
Urban™	SM	✓	✓	✓	✓	✓
Westport™	F/SM	✓	✓			✓

RETAINING WALLS

PRODUCT	FINISH	GARDENS	RETAINING WALLS	STEPS	SEATWALLS	PILLARS
Brussels Dimensional Stone®	W	✓		✓	✓	✓
DuraHold®	S		✓	✓	✓	
Estate Wall™	SP/W	✓	✓	✓	✓	✓
Lineo™ Dimensional Stone	S	✓		✓	✓	✓
Olde Quarry™	W	✓	✓	✓	✓	✓
Pisa™ & Pisa XL	S	✓	✓	✓	✓	✓
Pisa™ XL Smooth	S	✓	✓	✓	✓	✓
Quarry™ Smooth	S	✓	✓	✓	✓	✓
Rivercrest®	S	✓	✓	✓	✓	✓
SienaEdge™	S	✓	✓	✓	✓	
SienaStone®	SP		✓	✓		
U-Cara®	M	✓	✓	✓	✓	✓
Beacon Hill™ Coping	SM	✓		✓	✓	✓
Brussels Fullnose™ & Fullnose Edger	W	✓		✓	✓	
Ledgestone™	SM	✓		✓	✓	✓
Umbriano™ Coping	SM	✓		✓	✓	✓
Urban™ Coping	SM	✓		✓	✓	✓
Universal U-Grip™ Base	S	✓	✓	✓	✓	✓

Finishes: B=Brushed; C=Cobblestone; D=Dimpled; DW=Dimpled and Weathered; F=Flagstone; S=Standard; SM=Smooth; SZ=Smooth Zero Bevel; SP=Split; SP/W=Split and Weathered; T=Timeworn; W=Weathered; WS=Washed; M=Multi-Face. This application chart should only be used as a guide. Site conditions, base materials, pattern and frequency of use may vary the performance of various types and styles of products.



THE PERFECT MATCH FOR UNILOCK PAVERS



U-Cara™



SienaEdge™



Estate Wall™

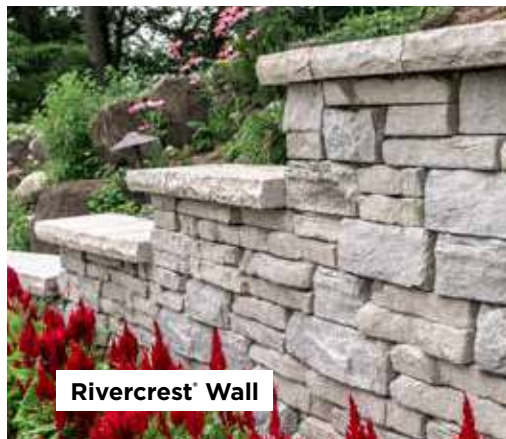

Rivercrest™ Wall



Quarry Smooth™



UNILOCK WALLS: STRENGTH MEETS STYLE

Complete your projects with wall blocks designed to coordinate seamlessly with Unilock pavers. Rich textures and premium colors create cohesive outdoor spaces, with blocks that deliver four times the industry standard for strength.

Let's **BUILD YOUR BUSINESS TOGETHER.**

CONTACT 1-800-UNILOCK OR VISIT UNILOCK.COM TO
CONNECT WITH YOUR LOCAL TERRITORY MANAGER

CHICAGO

(630) 892-9191

MILWAUKEE

(262) 742-3890

KANSAS

(913) 417-7985

BOSTON

(508) 278-4536

NEW YORK

(845) 278-6700

MID-ATLANTIC

(202) 798-2060

MICHIGAN

(248) 437-7037

CINCINNATI/KY/TN

(513) 202-0219

**OHIO/WESTERN PA/
WNY&CNY**

(330) 927-4000

ONTARIO

(416) 646-9000

UNILOCK®

UNILOCK.COM | 1-800-UNILOCK

